

INOVAÇÃO, SEGURANÇA E RENTABILIDADE



THE ONE
High Loft

O INVESTIMENTO CERTO.

 SÃO PAULO - SP

1º ANDAR

Studios Pé Direito 2,60 m





UNIDADE STUDIO PD PADRÃO
FINAL 03 - ANDAR TIPO 1º
33,27 m² - Opção de Layout 03

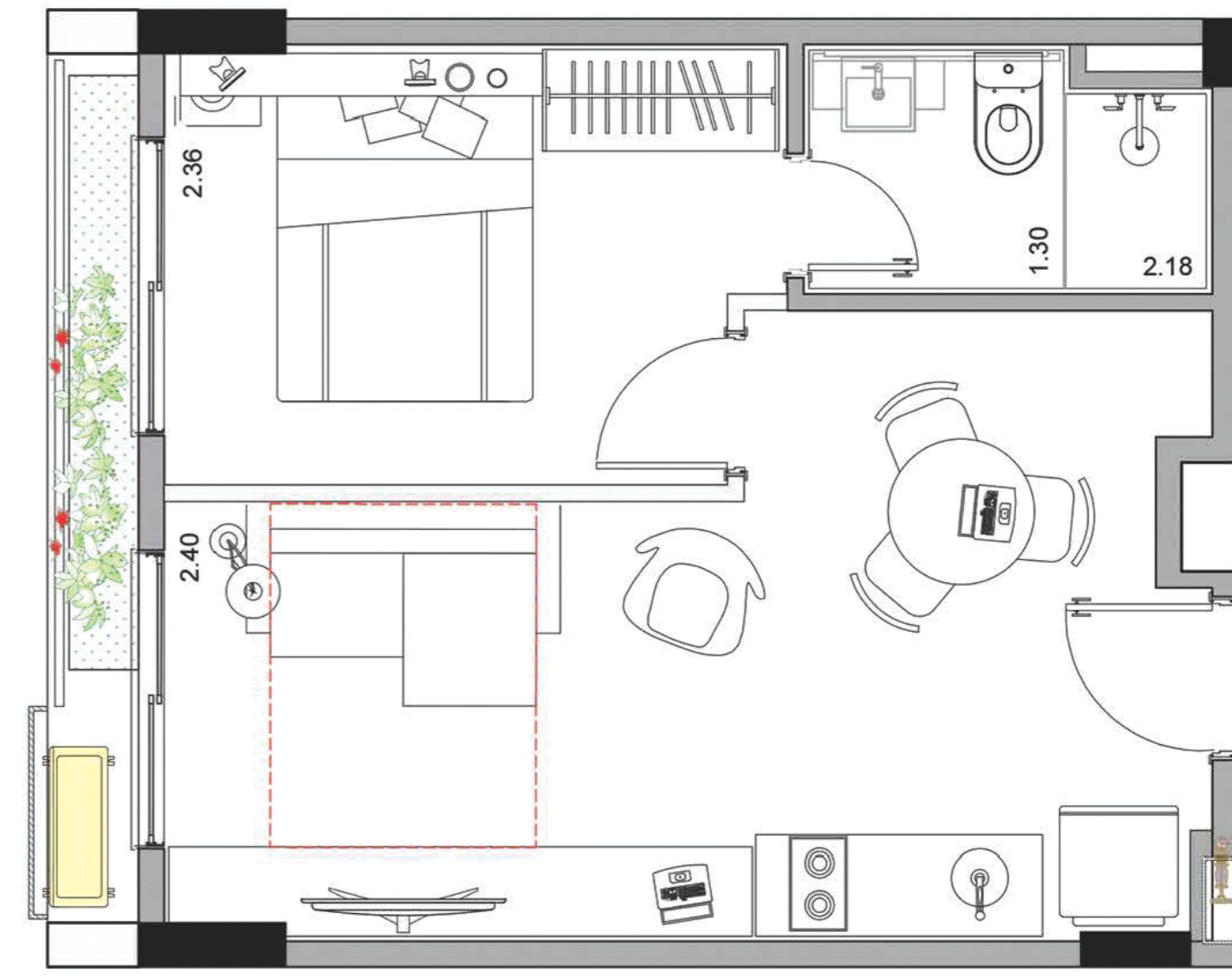

UNIDADE STUDIO PD PADRÃO
FINAL 04 - ANDAR TIPO 1º
32,54 m²

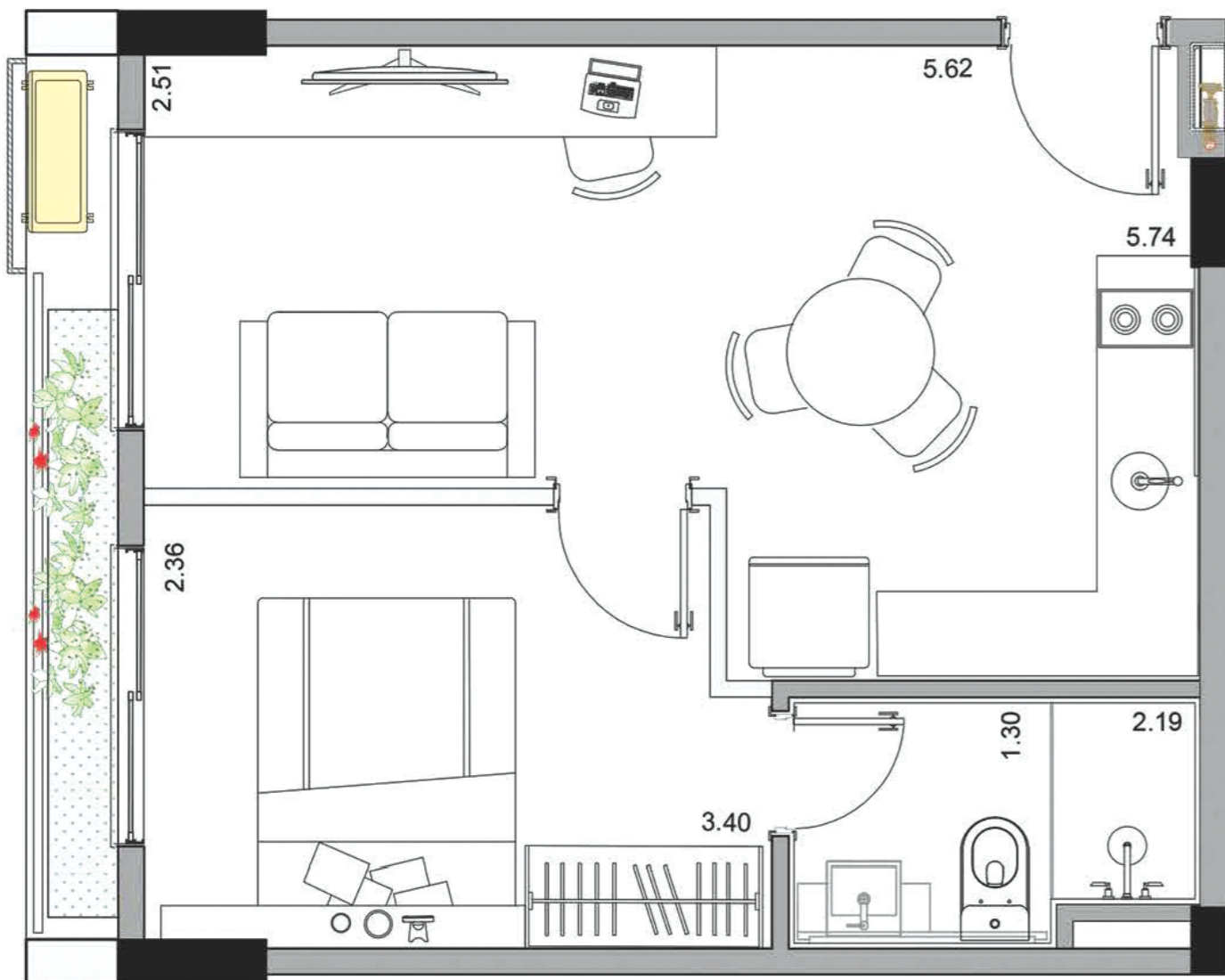

UNIDADE STUDIO PD PADRÃO
FINAL 05 - ANDAR TIPO 1º
23,79 m²

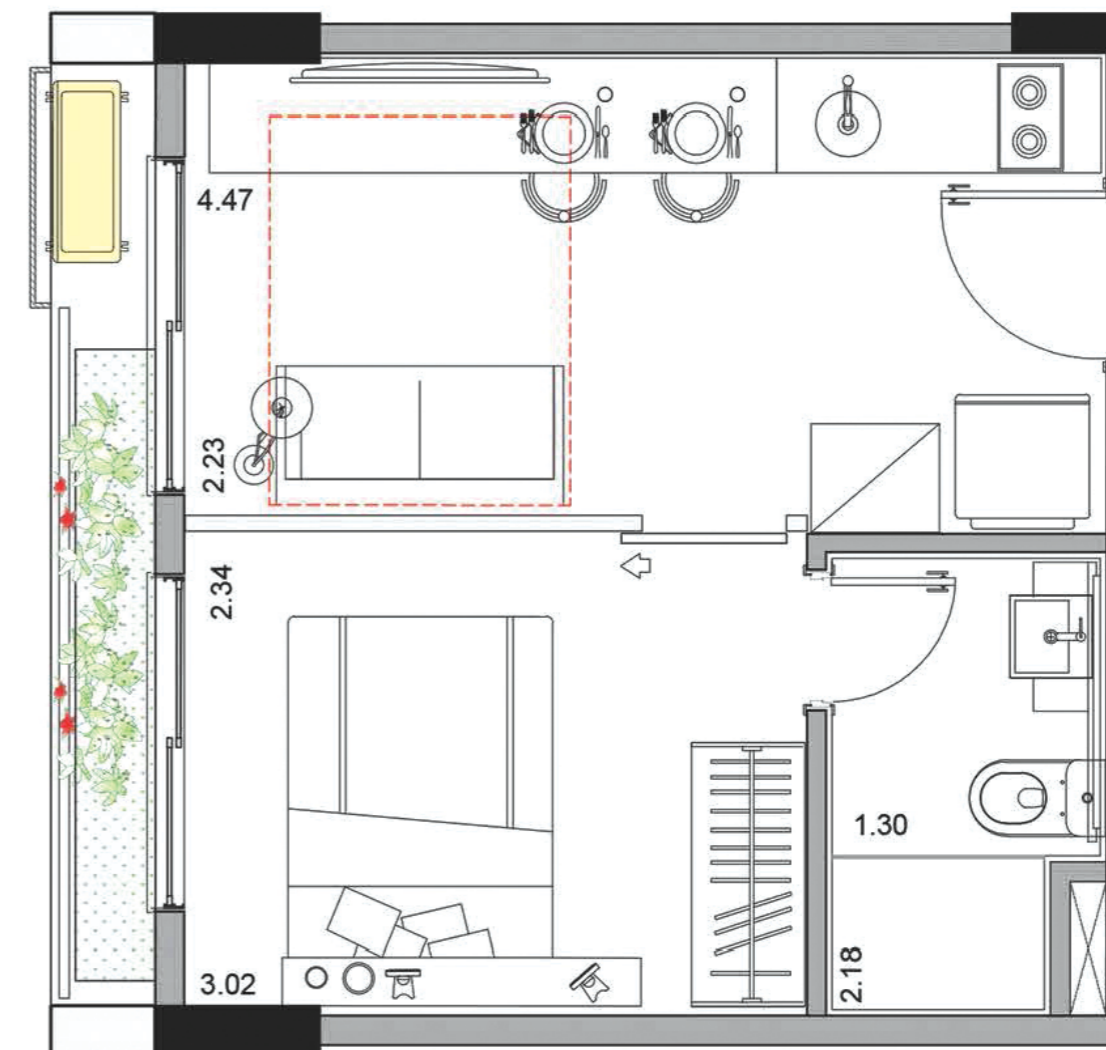

UNIDADE STUDIO PD PADRÃO
FINAL 06 - ANDAR TIPO 1º
27,12 m²

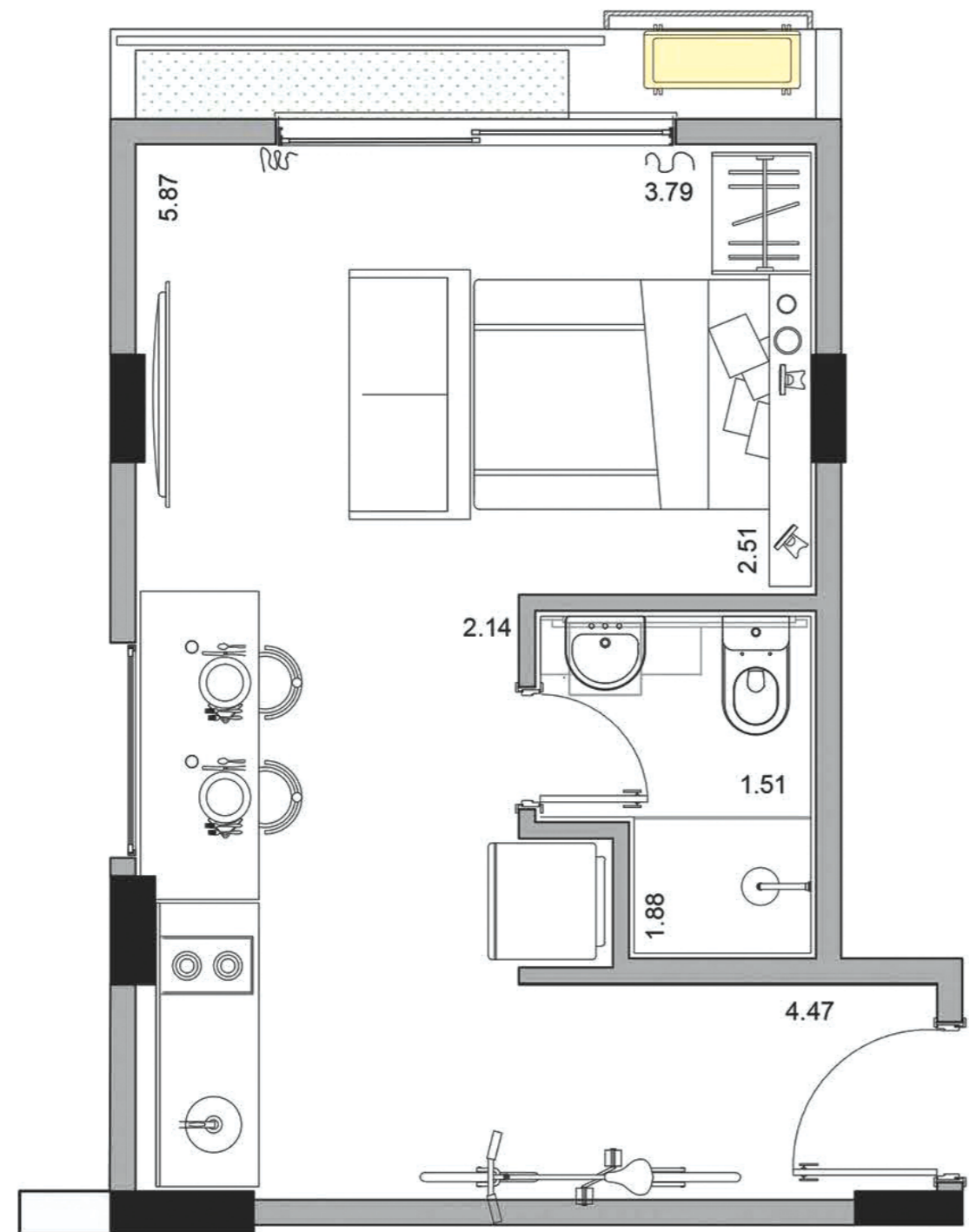

UNIDADE STUDIO PD PADRÃO
FINAL 07 - ANDAR TIPO 1º
19,76 m²

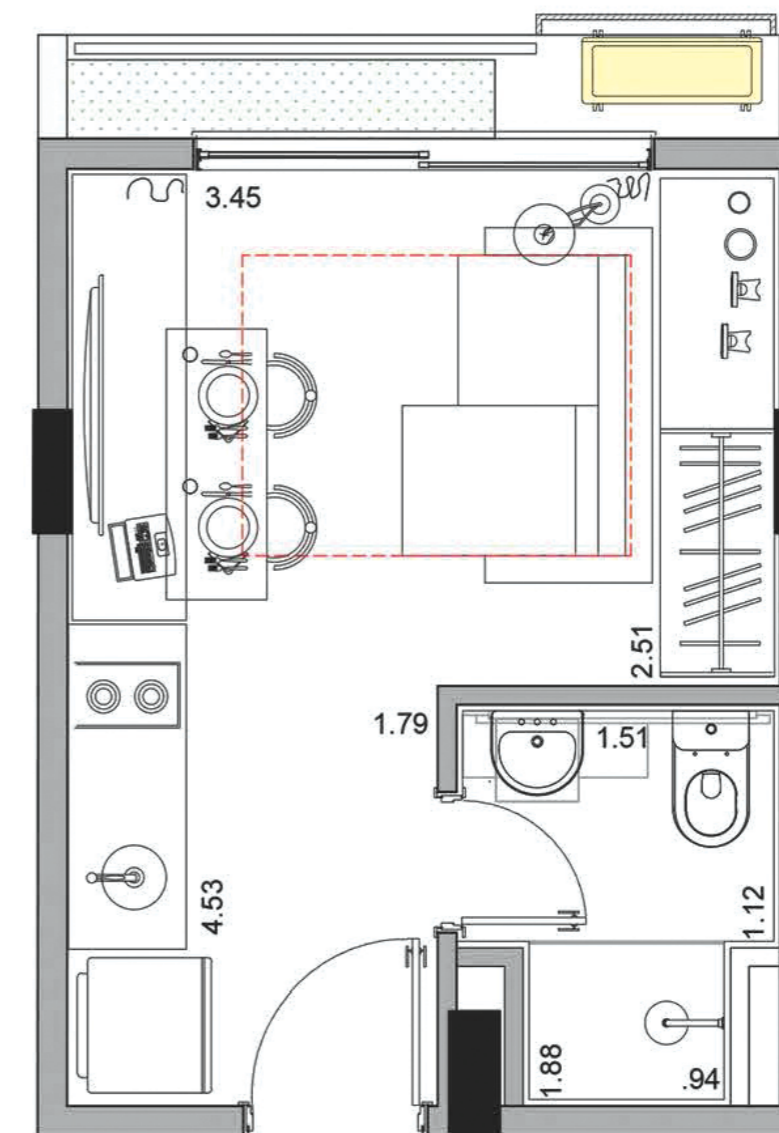

UNIDADE STUDIO PD PADRÃO
FINAL 08 - ANDAR TIPO 1º
19,76 m² - Opção de Layout 02

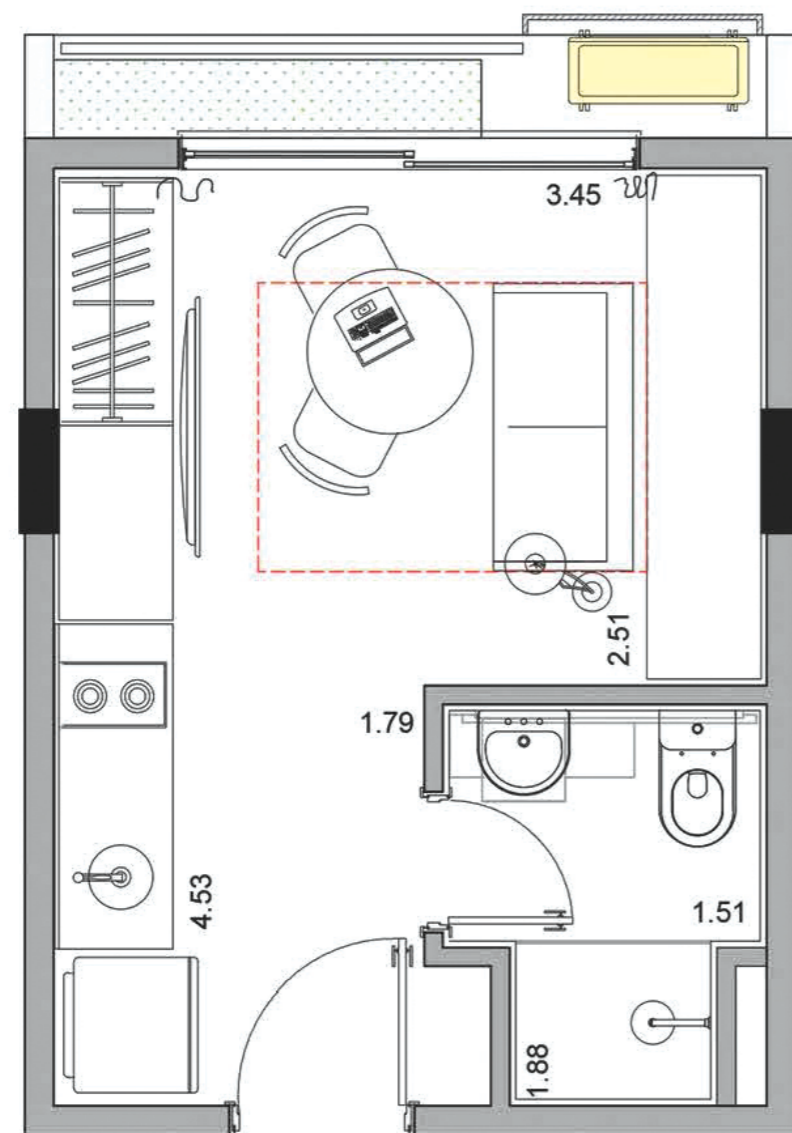

UNIDADE STUDIO PD PADRÃO
FINAL 09 - ANDAR TIPO 1º
29,30m²

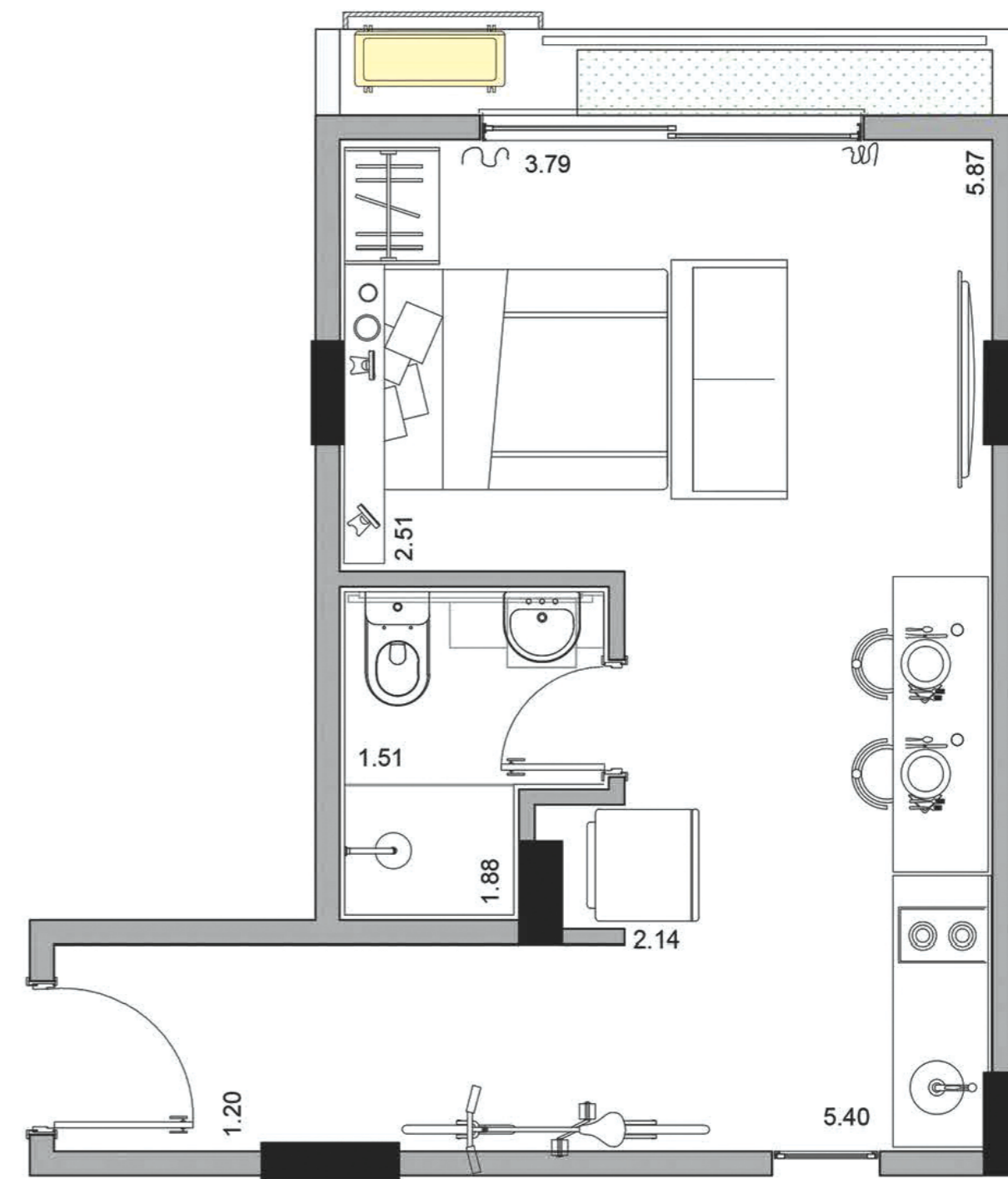

UNIDADE STUDIO PD PADRÃO
FINAL 10 - ANDAR TIPO 1º
31,65 m²

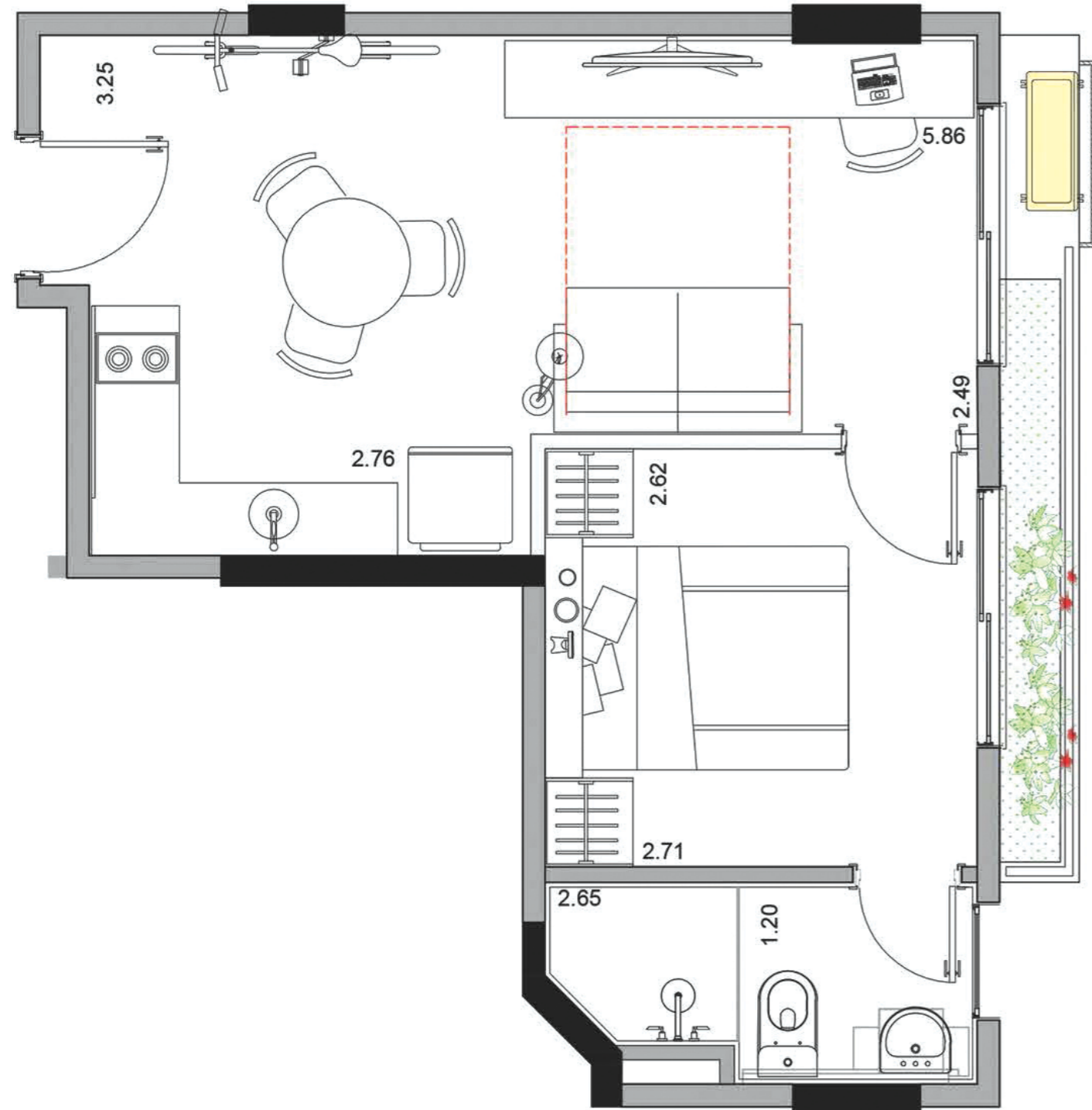

UNIDADE STUDIO PD PADRÃO
FINAL 11 - ANDAR TIPO 1º
38,37 m²

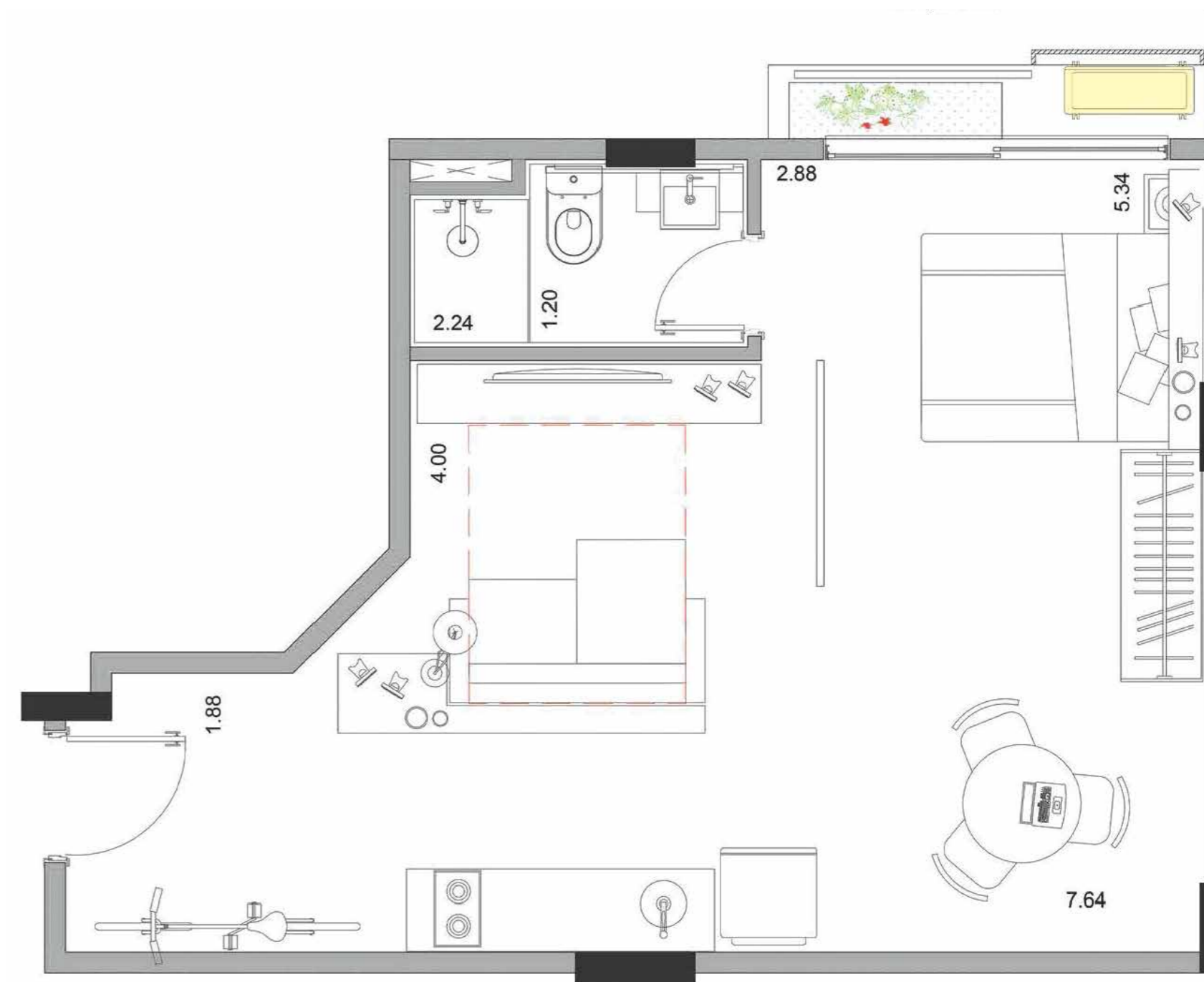

2° - 8° ANDAR

Studios Pé Direito 2,60 m





UNIDADE STUDIO PD PADRÃO
FINAL 01 - ANDAR TIPO 2º e 3º
23,76 m²

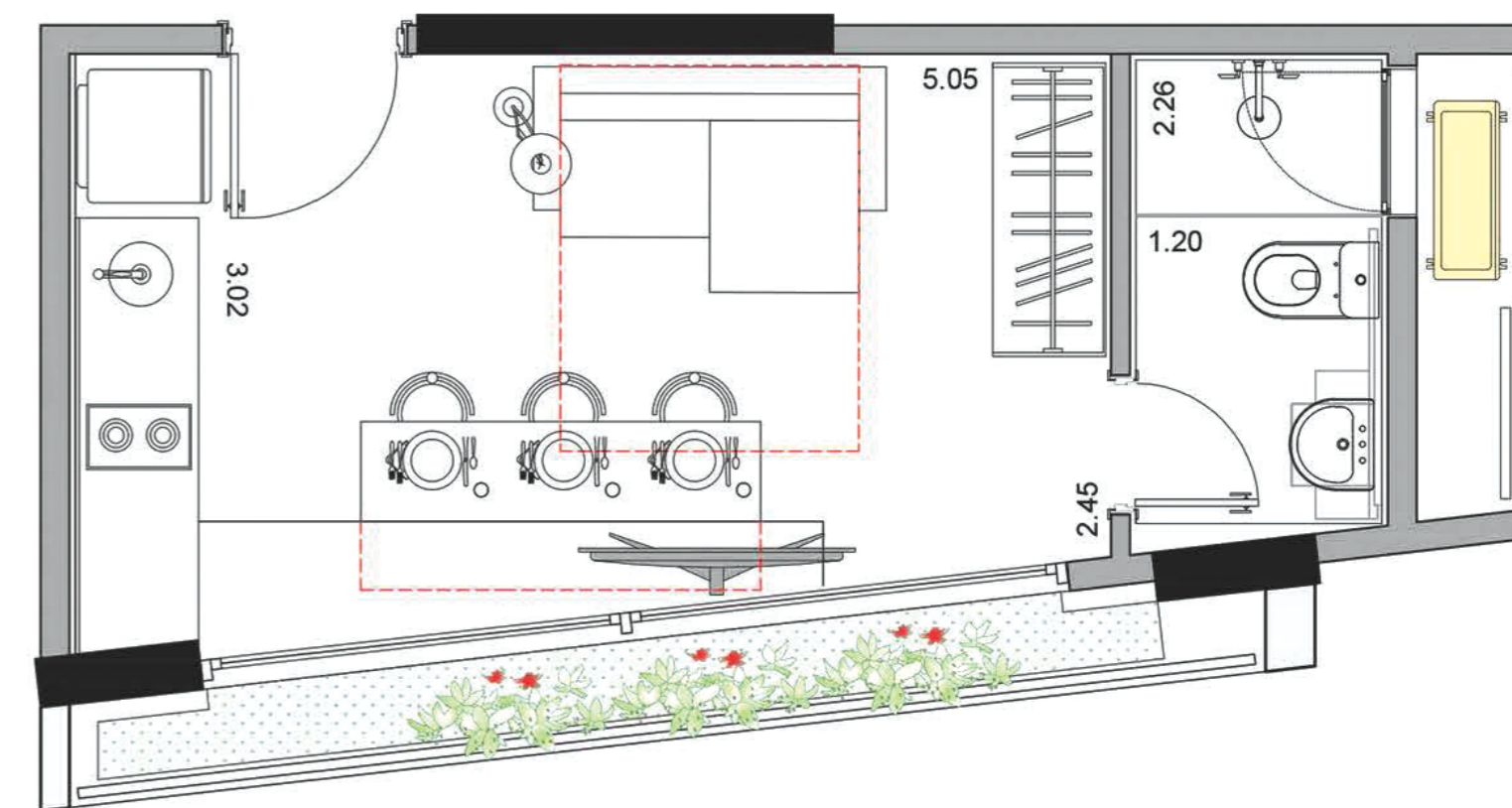

UNIDADE STUDIO PD PADRÃO
FINAL 02 - ANDAR TIPO 2º e 3º
29,56 m² - Opção de Layout 03

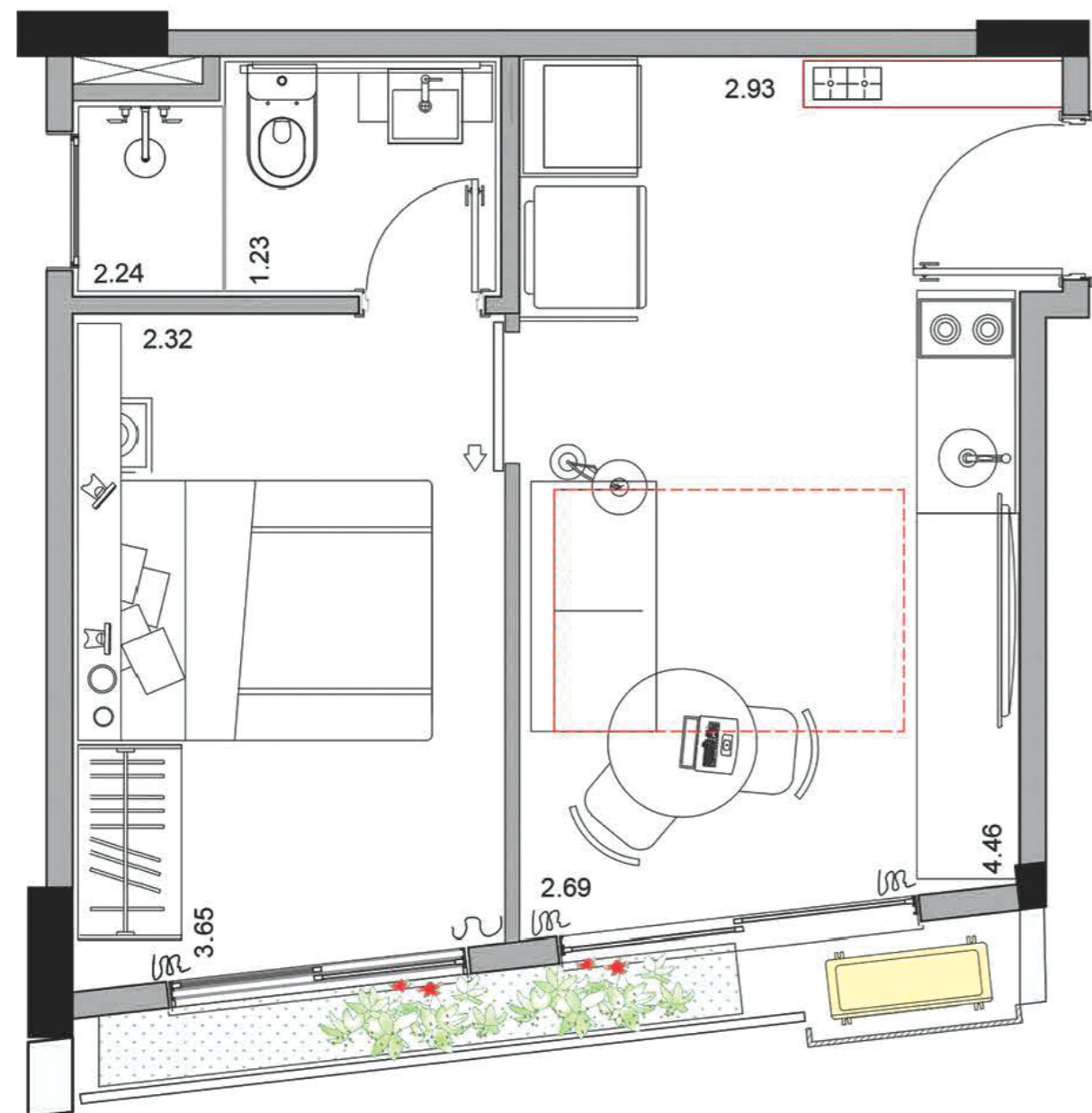

UNIDADE STUDIO PD PADRÃO
FINAL 03 - ANDAR TIPO 2º e 3º
33,27 m² - Opção de Layout 02

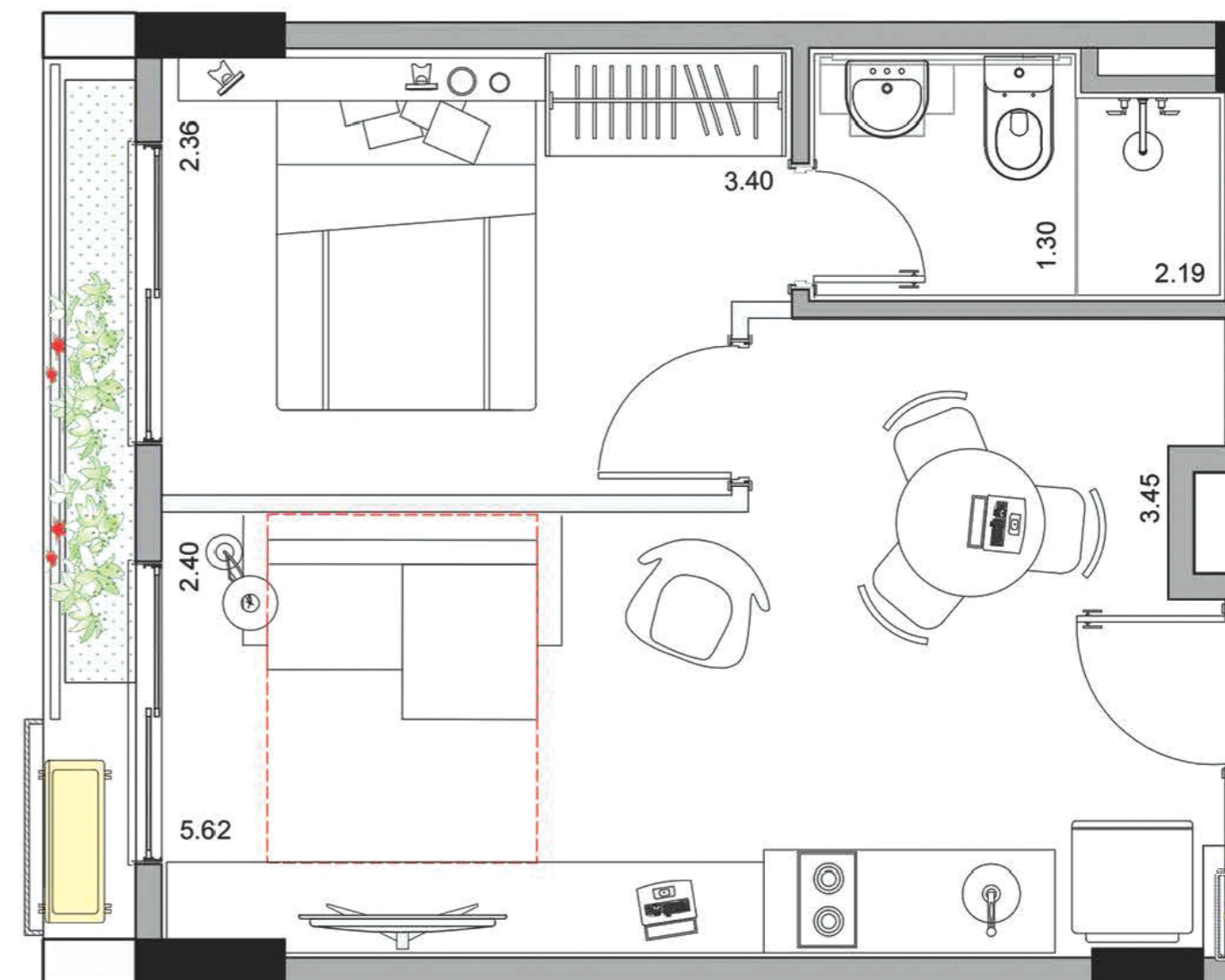

UNIDADE STUDIO PD PADRÃO
FINAL 04 - ANDAR TIPO 2º e 3º
32,54 m²

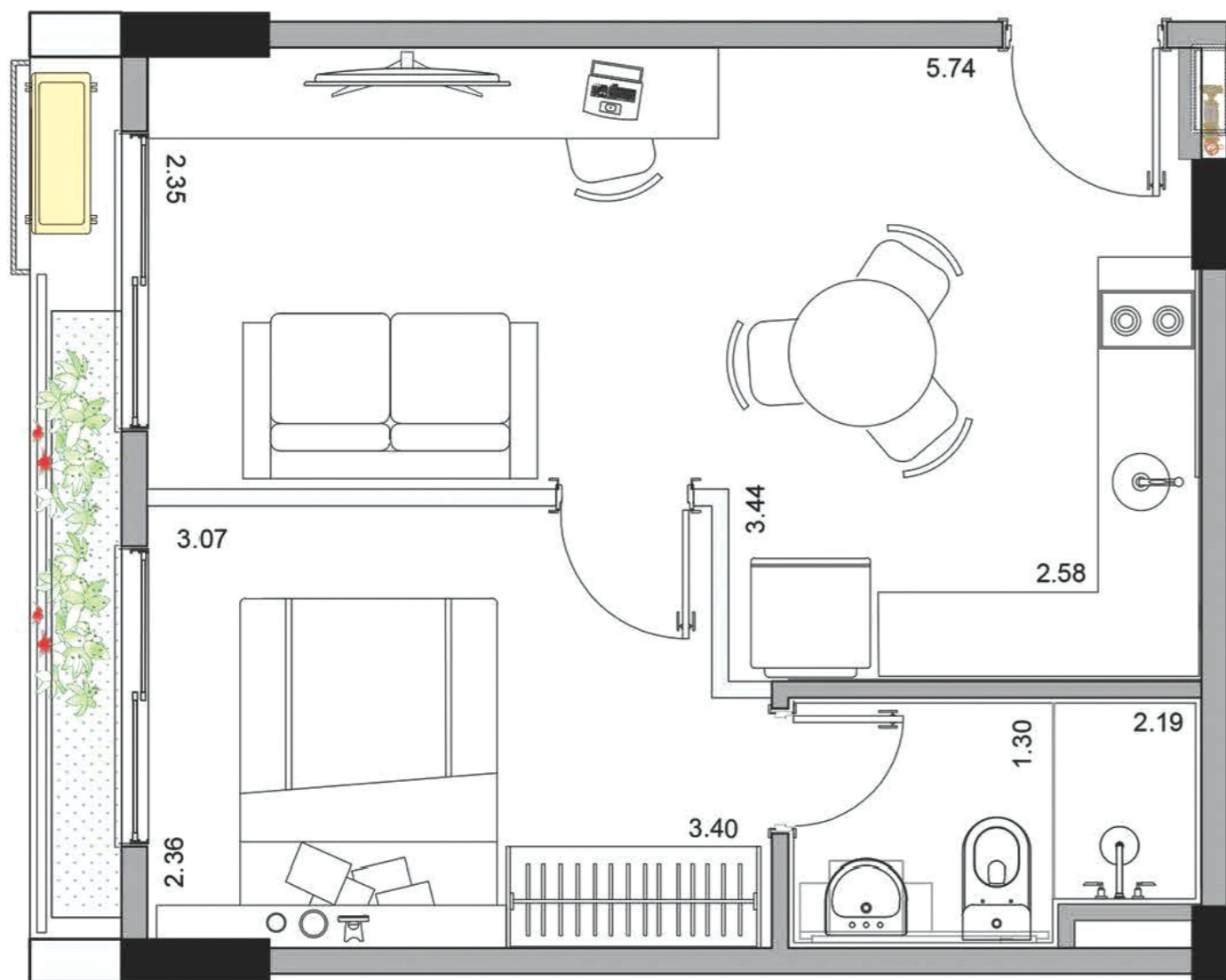

UNIDADE STUDIO PD PADRÃO
FINAL 05 - ANDAR TIPO 2º e 3º
23,79 m²

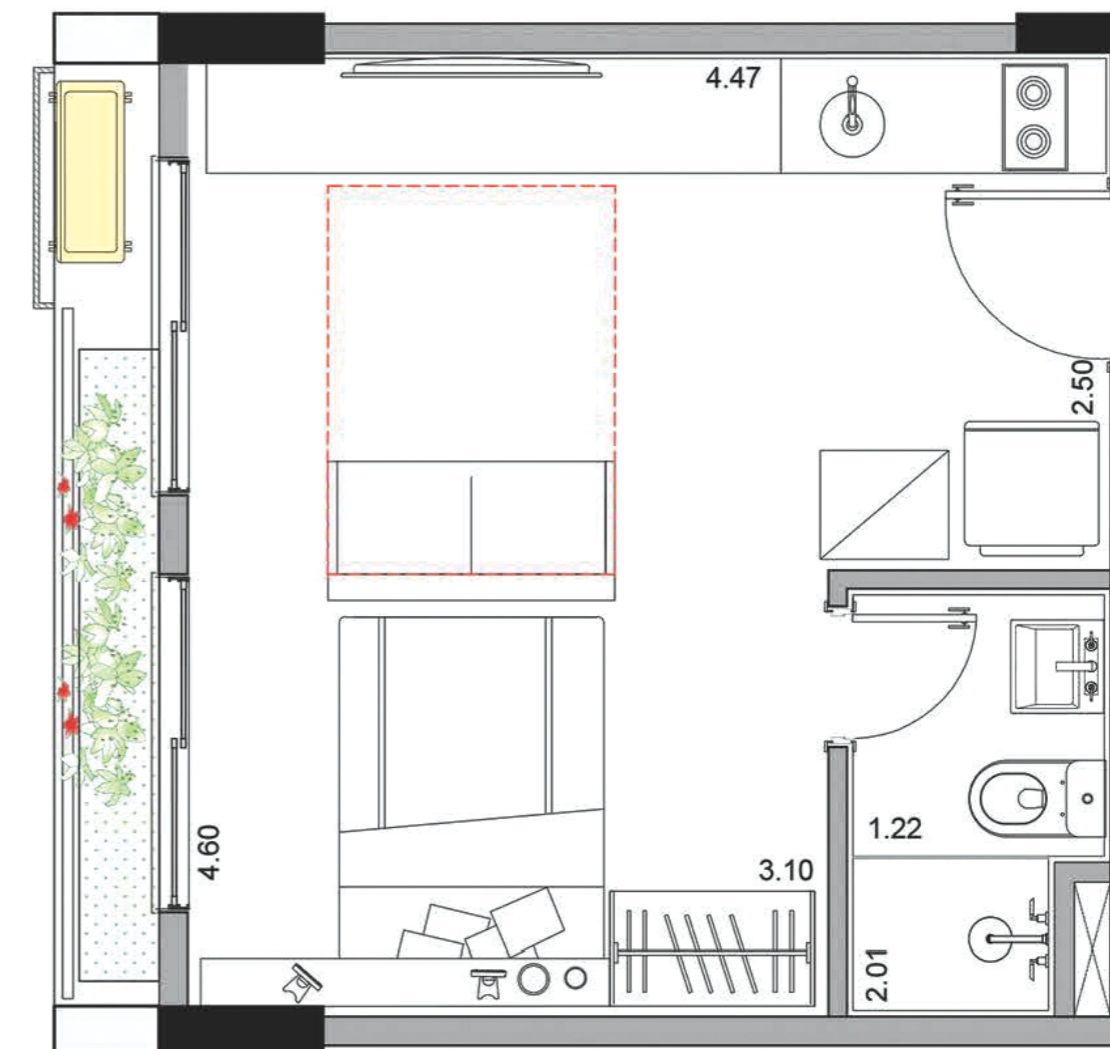

UNIDADE STUDIO PD PADRÃO
FINAL 06 - ANDAR TIPO 2º e 3º
27,12 m²

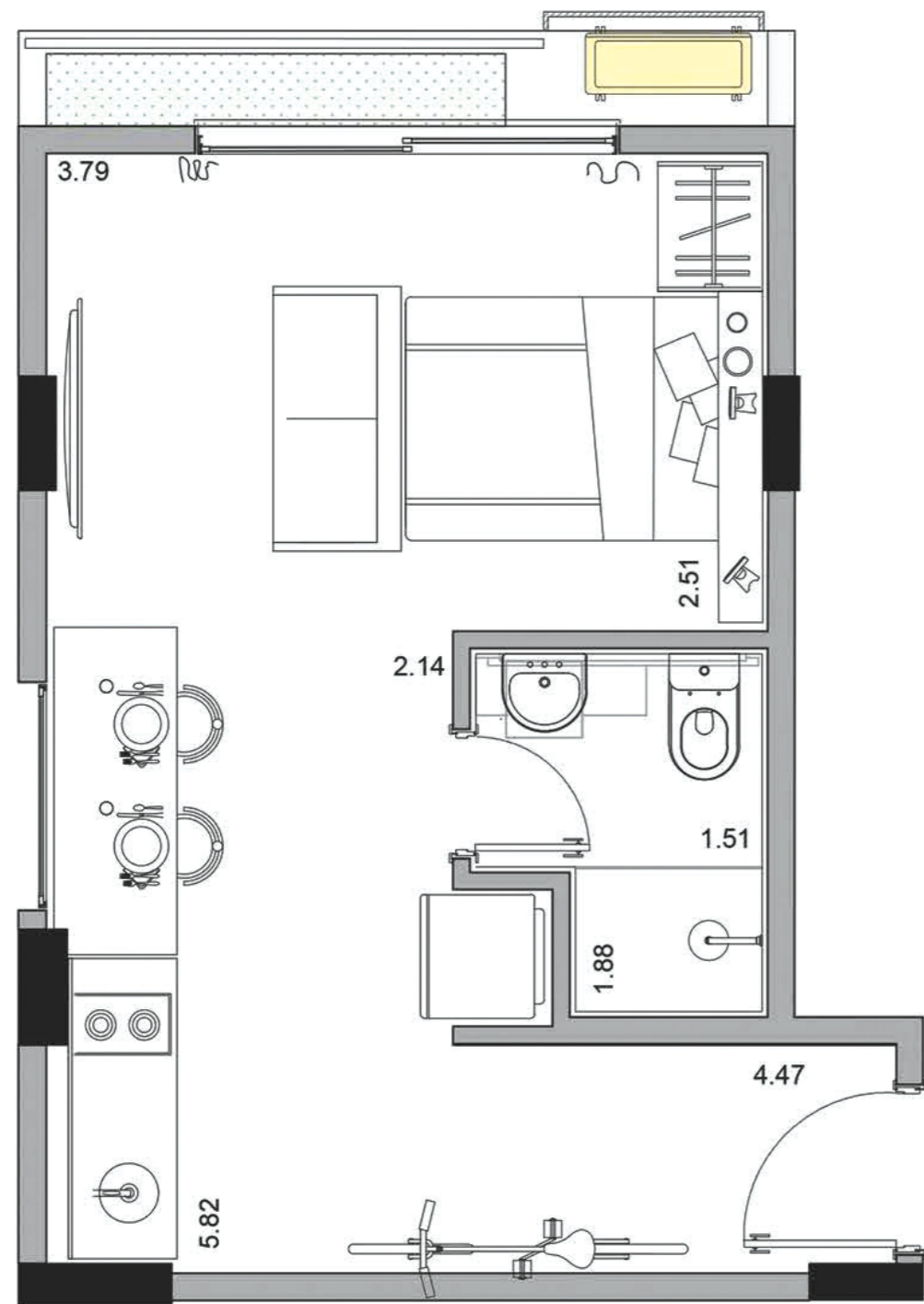

UNIDADE STUDIO PD PADRÃO
FINAL 07 - ANDAR TIPO 2º e 3º
19,76 m²

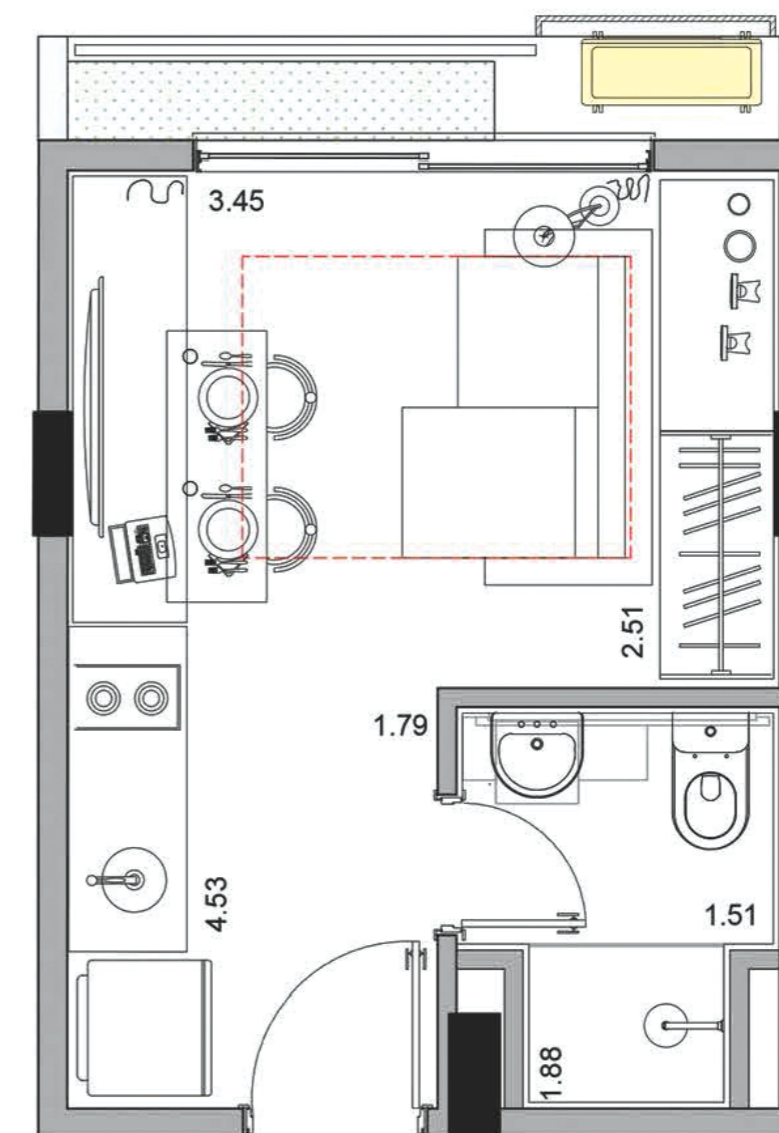

UNIDADE STUDIO PD PADRÃO
FINAL 08 - ANDAR TIPO 2º e 3º
19,76 m² - Opção de Layout 02

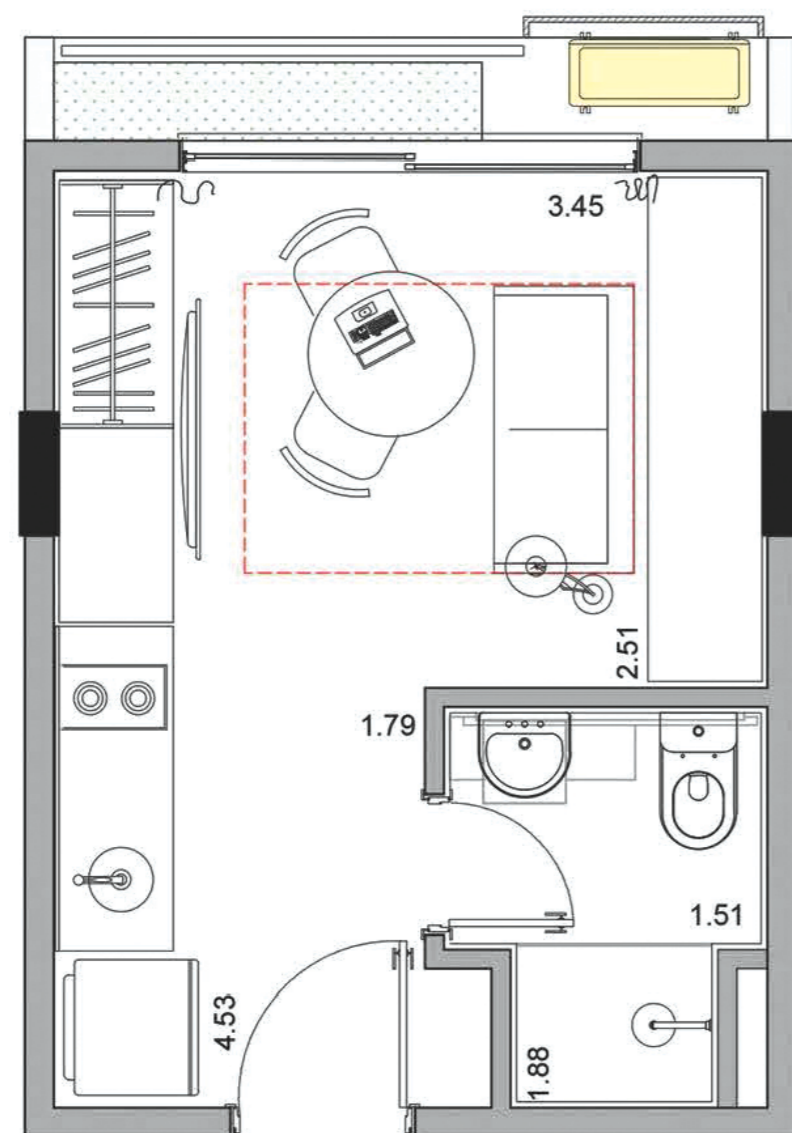

UNIDADE STUDIO PD PADRÃO
FINAL 09 - ANDAR TIPO 2º e 3º
29,30 m²

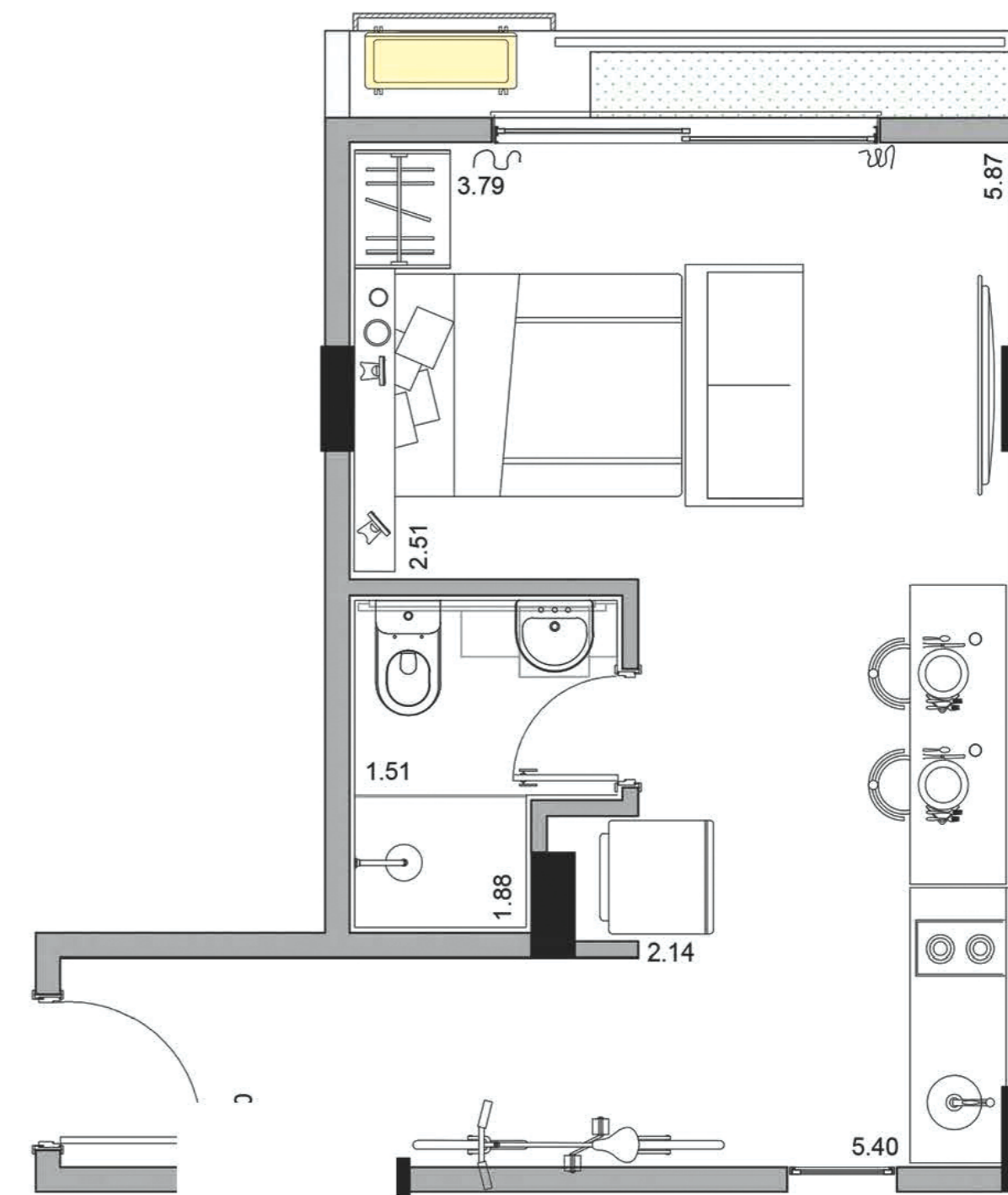

UNIDADE STUDIO PD PADRÃO
FINAL 09 - ANDAR TIPO 2º e 3º
29,30 m²

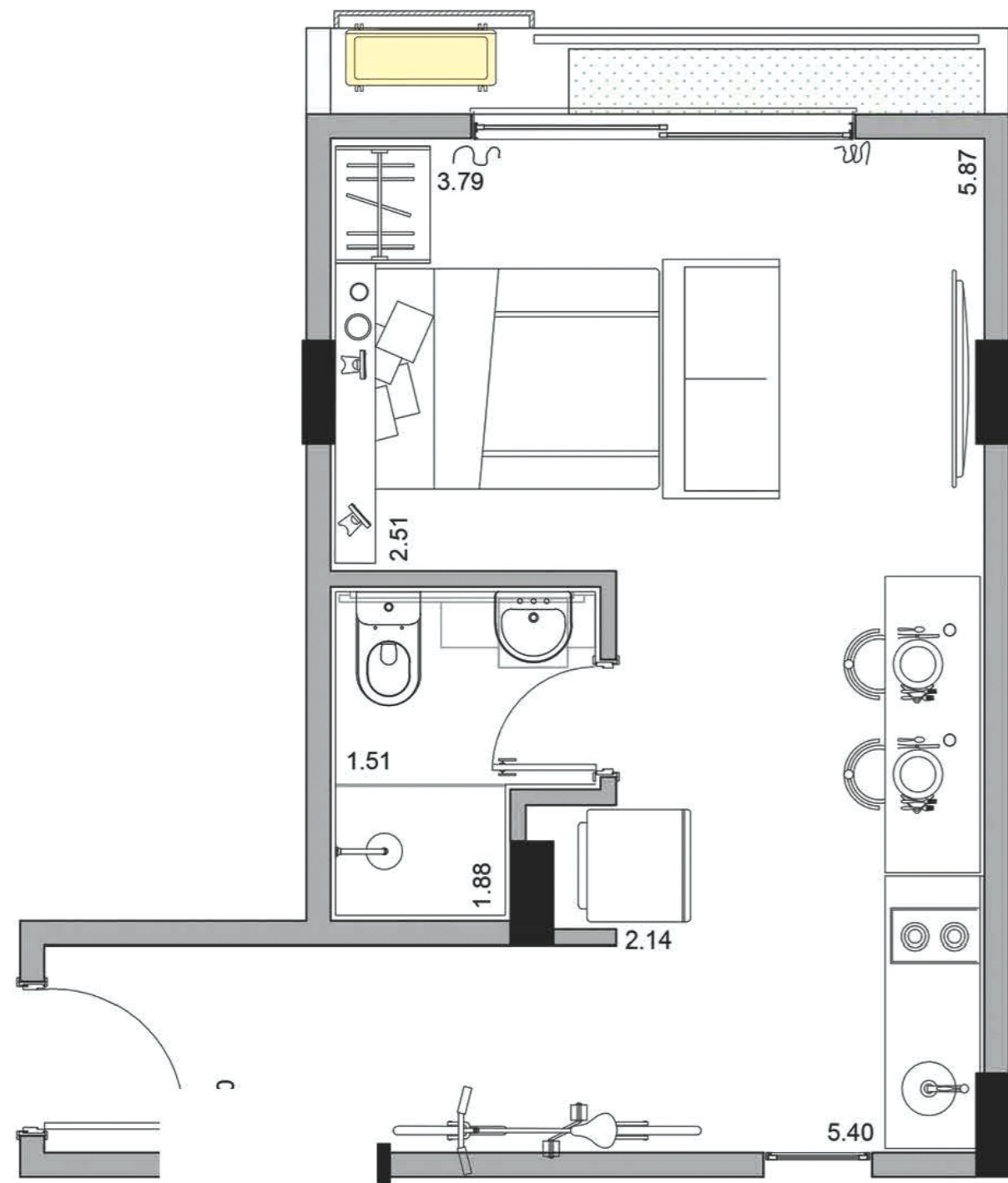

UNIDADE STUDIO PD PADRÃO
FINAL 10 - ANDAR TIPO 2º e 3º
31,65 m²

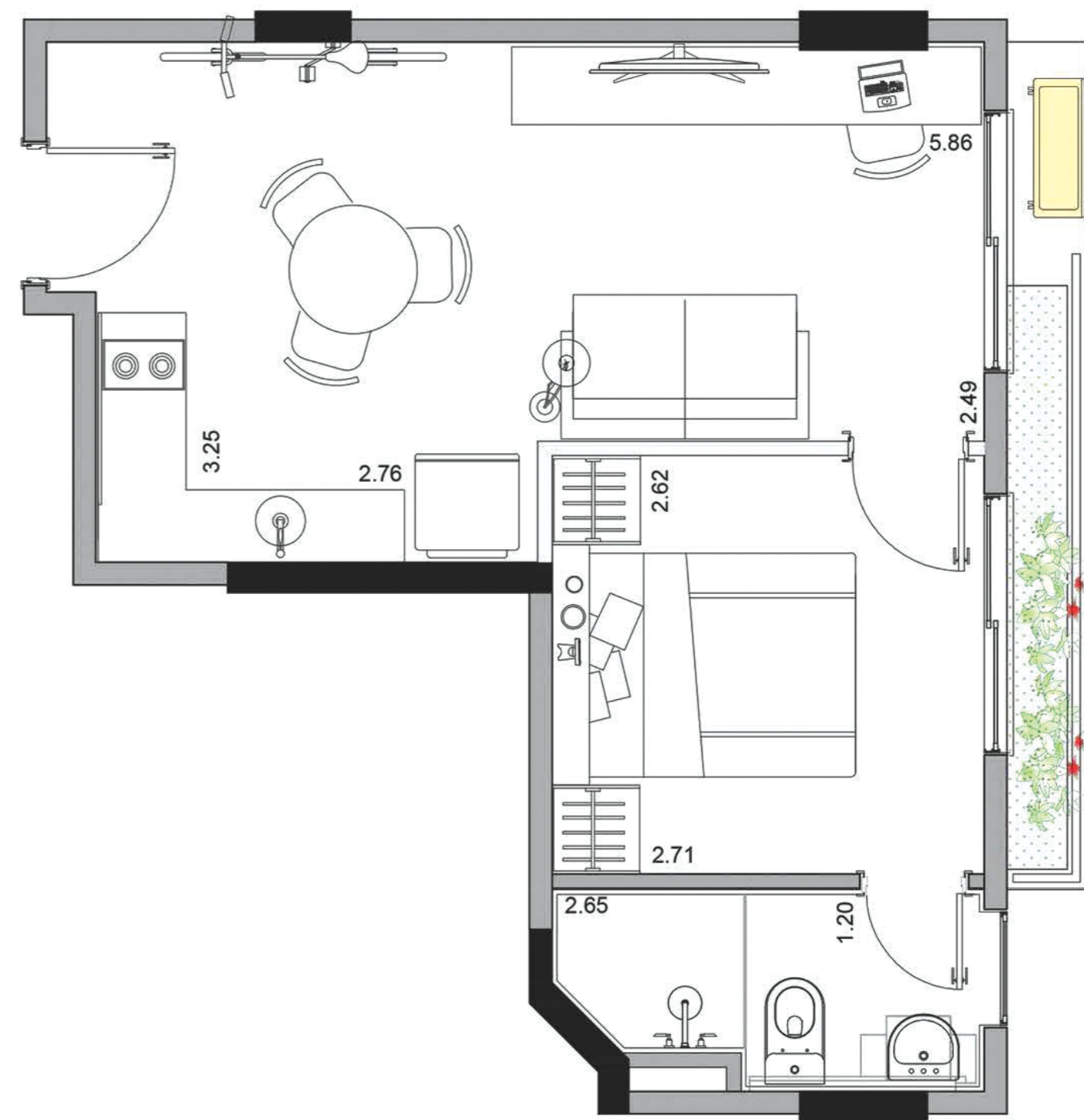

UNIDADE STUDIO PD PADRÃO
FINAL 11 - ANDAR TIPO 2º e 3º
38,00 m²

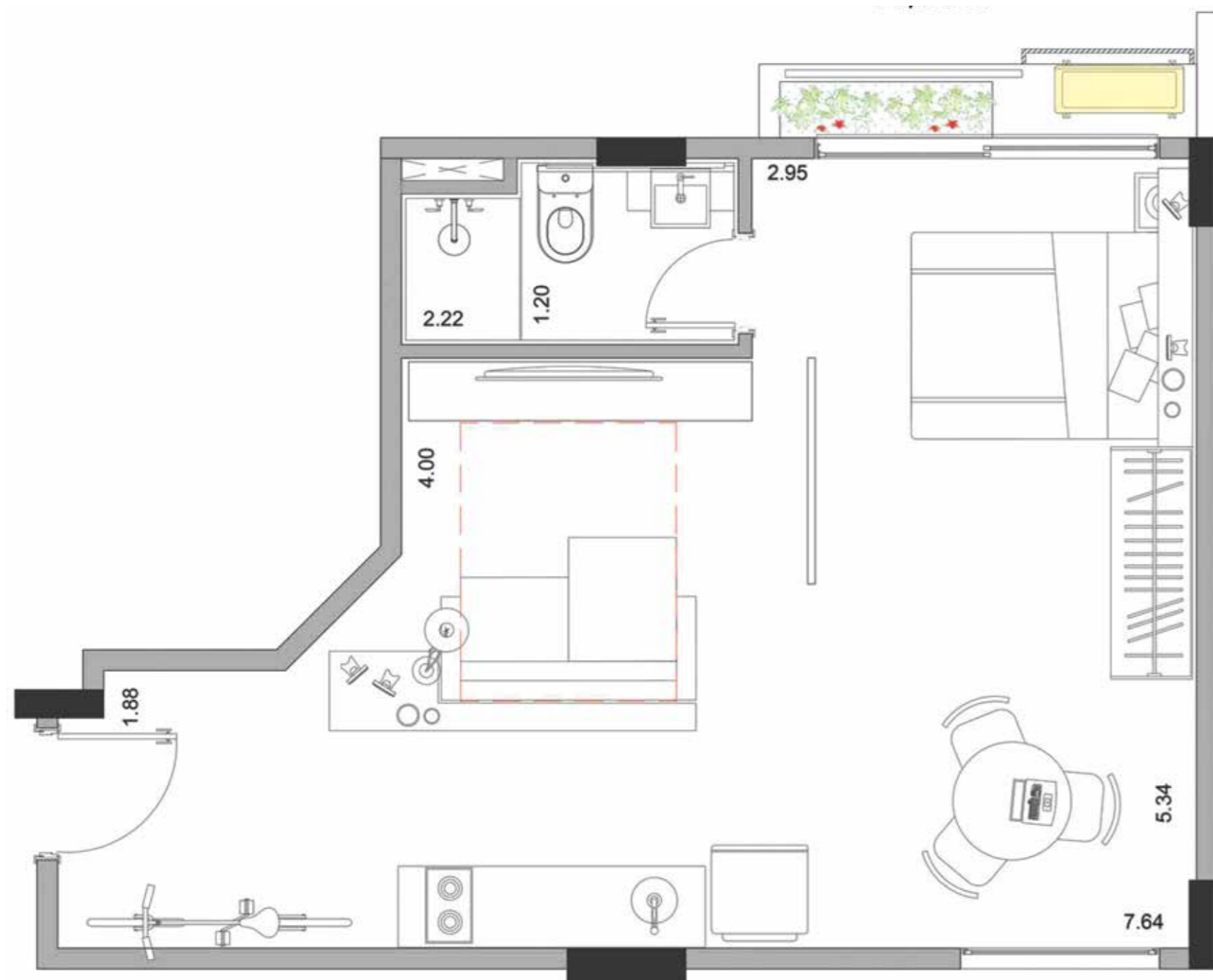

UNIDADE STUDIO PD PADRÃO
FINAL 12 - ANDAR TIPO 2º e 3º
19,60 m²

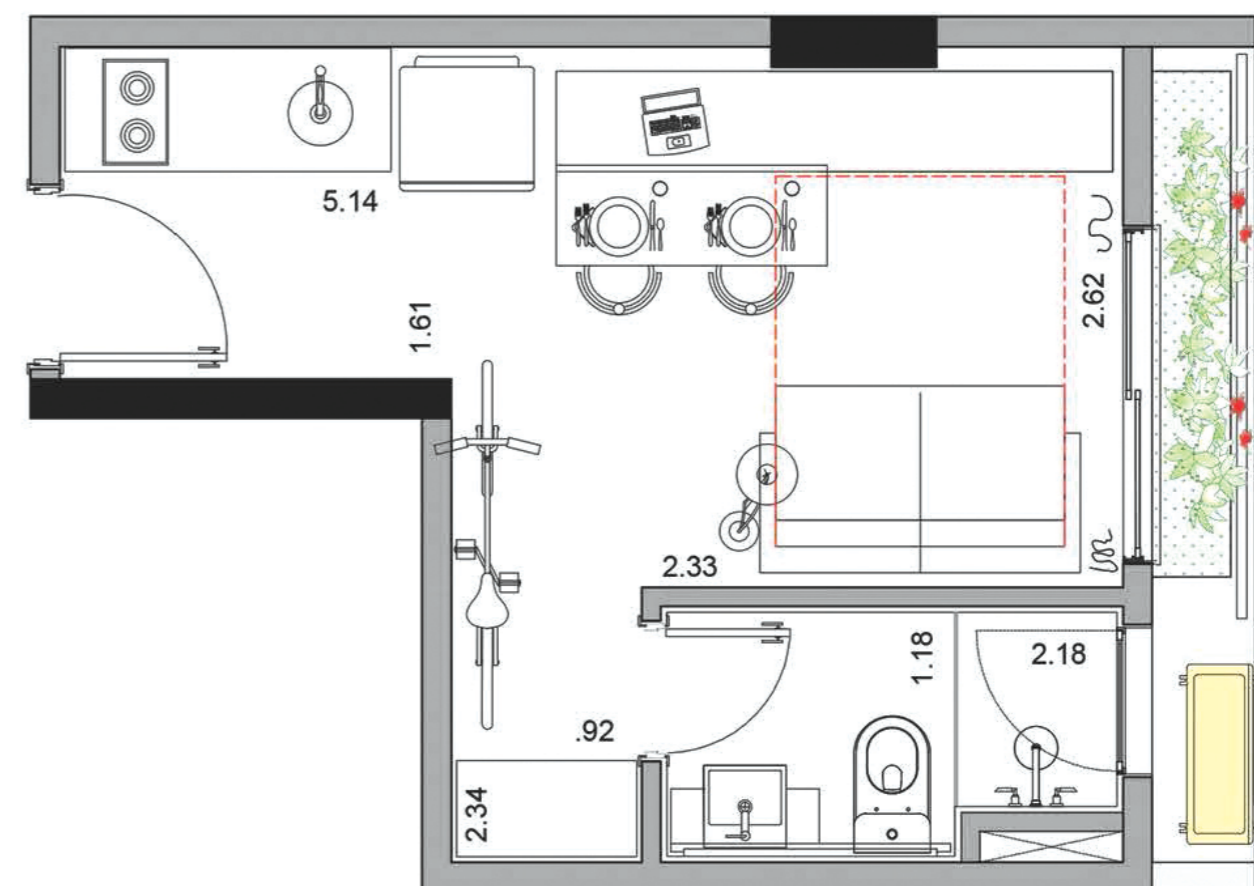

UNIDADE STUDIO PD PADRÃO
FINAL 01 - ANDAR TIPO 4º
23,20 m²

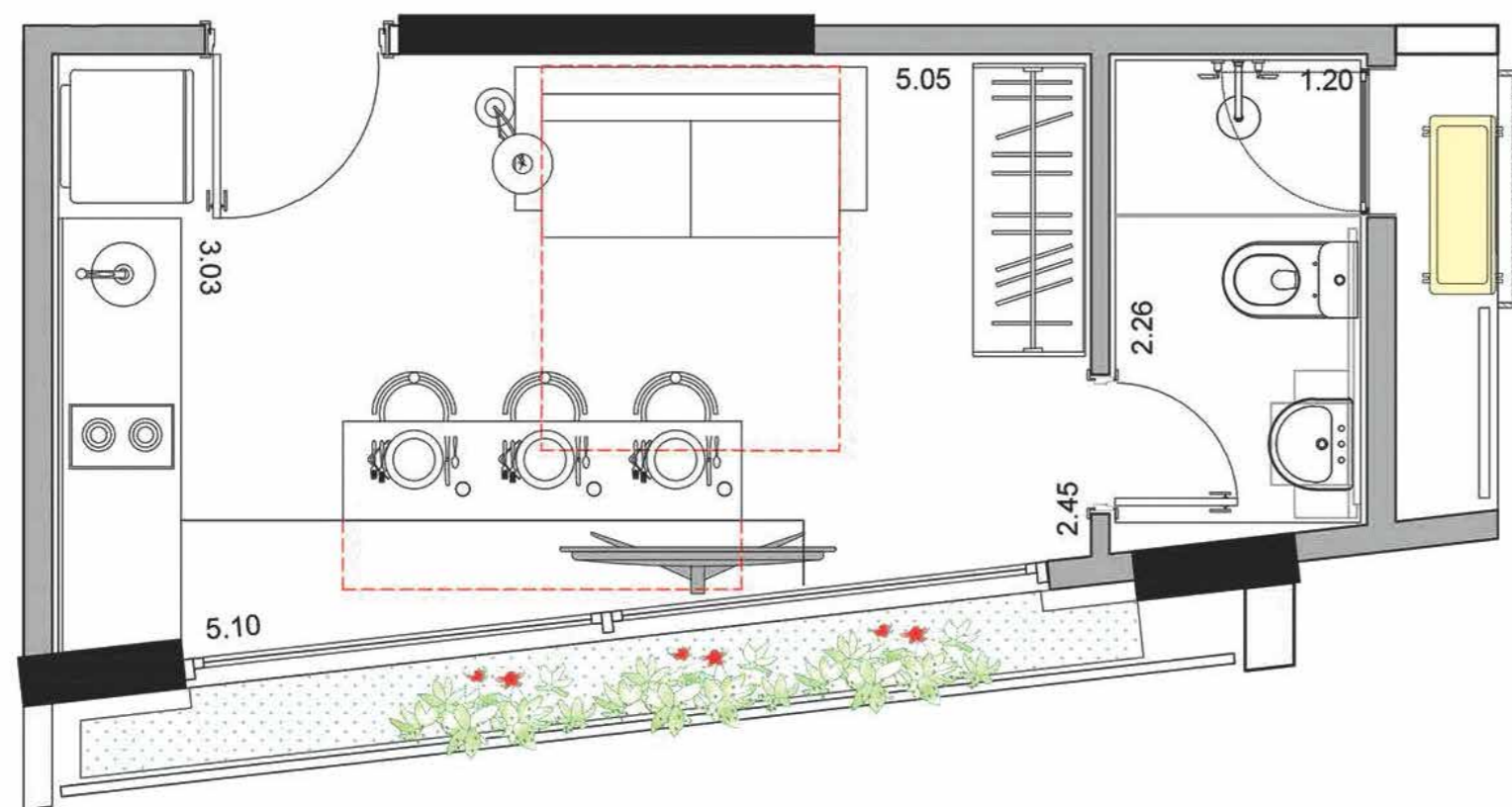

UNIDADE STUDIO PD PADRÃO
FINAL 02 - ANDAR TIPO 4º
29,56 m²

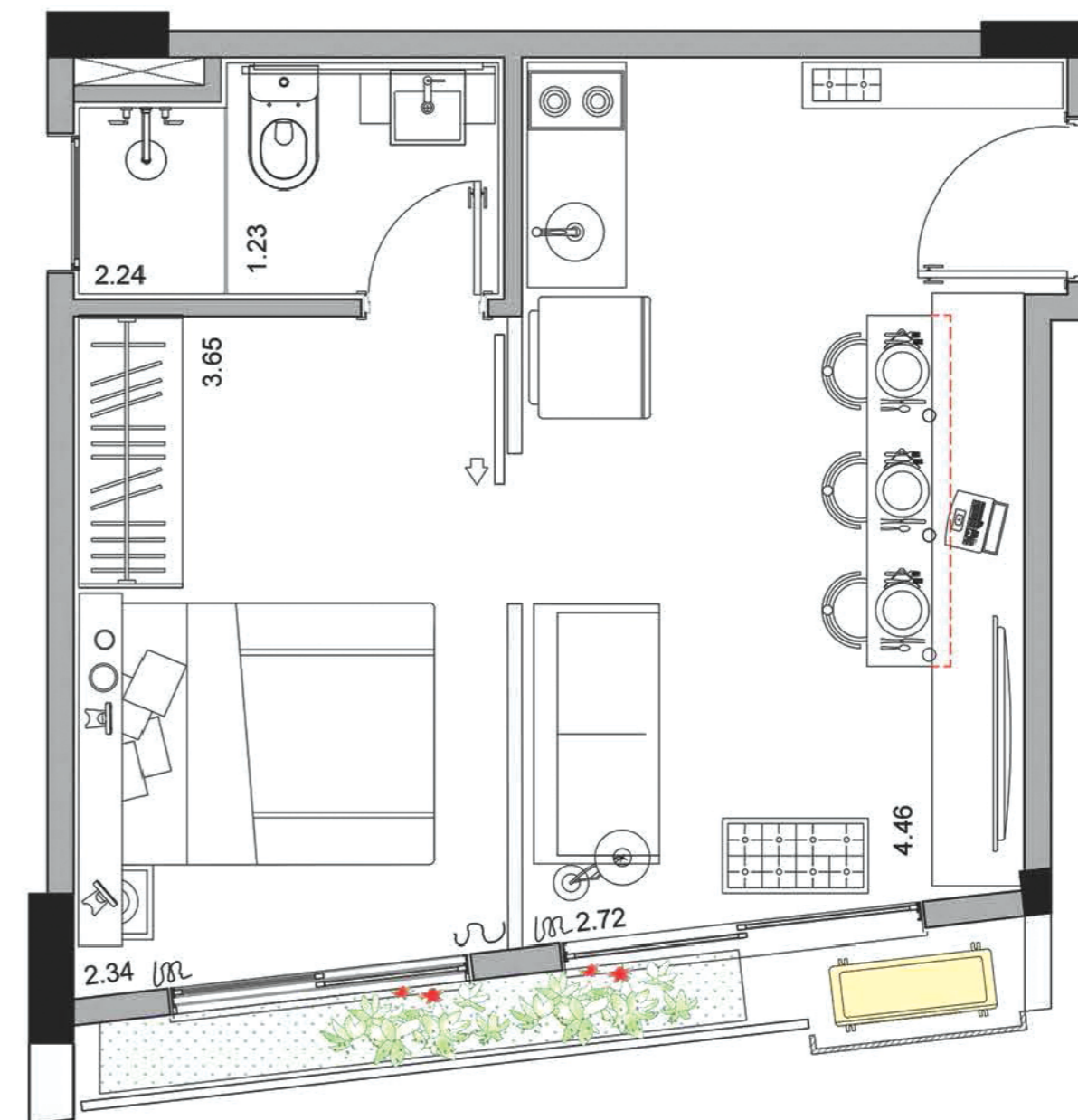

UNIDADE STUDIO PD PADRÃO
FINAL 03 - ANDAR TIPO 4º
33,27 m²

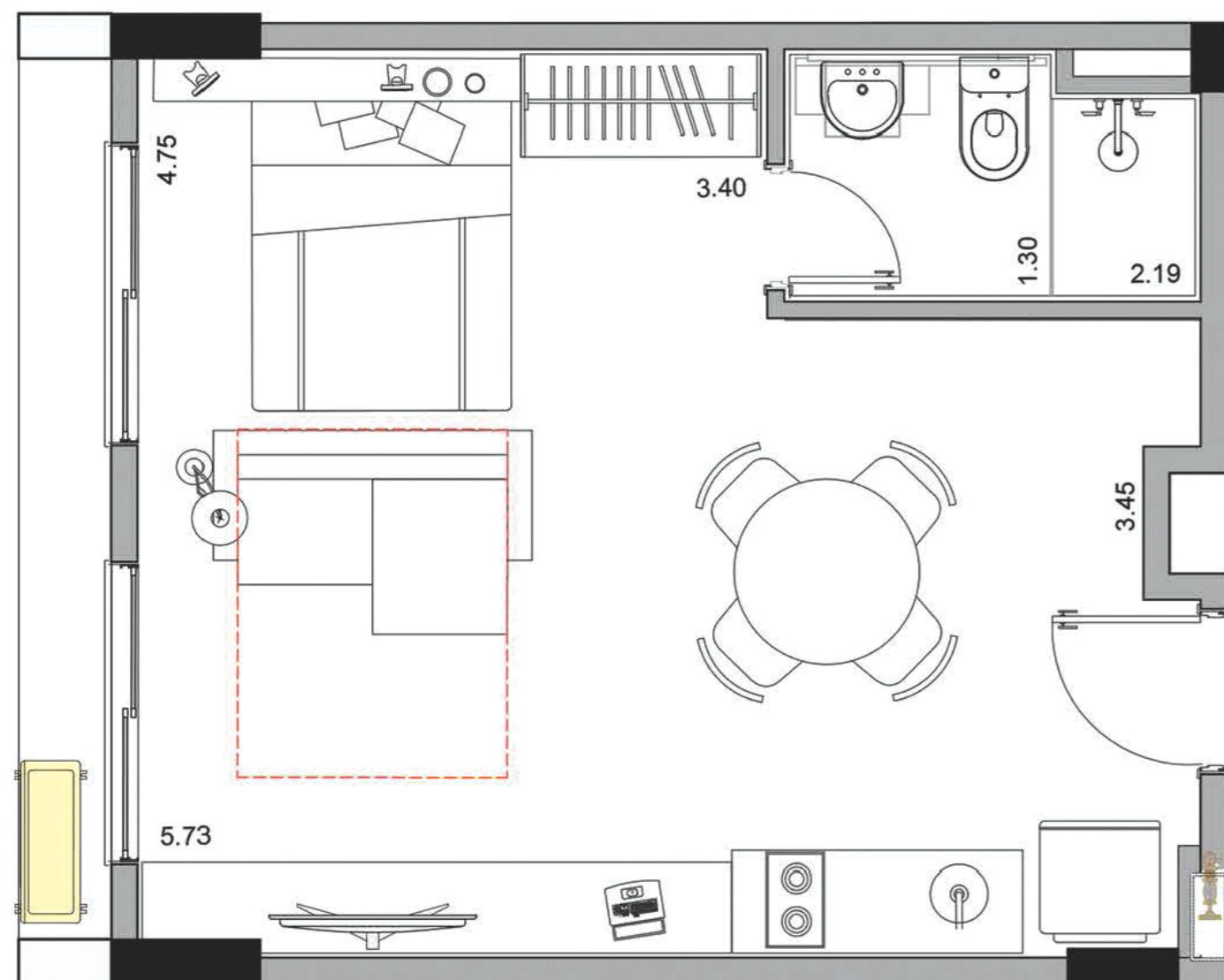

UNIDADE STUDIO PD PADRÃO
FINAL 04 - ANDAR TIPO 4º
32,54 m² - Opção de Layout 02

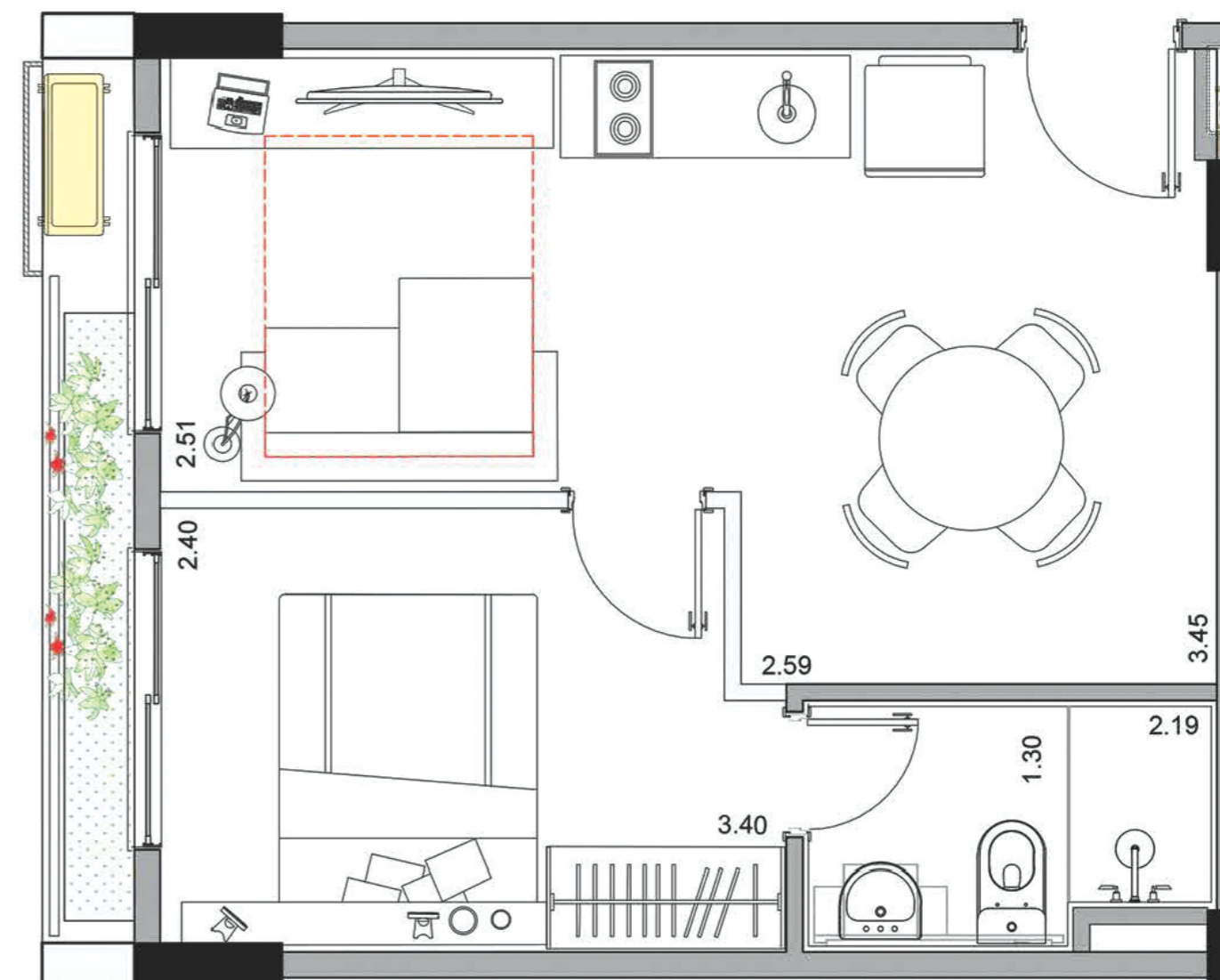

UNIDADE STUDIO PD PADRÃO
FINAL 05 - ANDAR TIPO 4º
23,79 m²

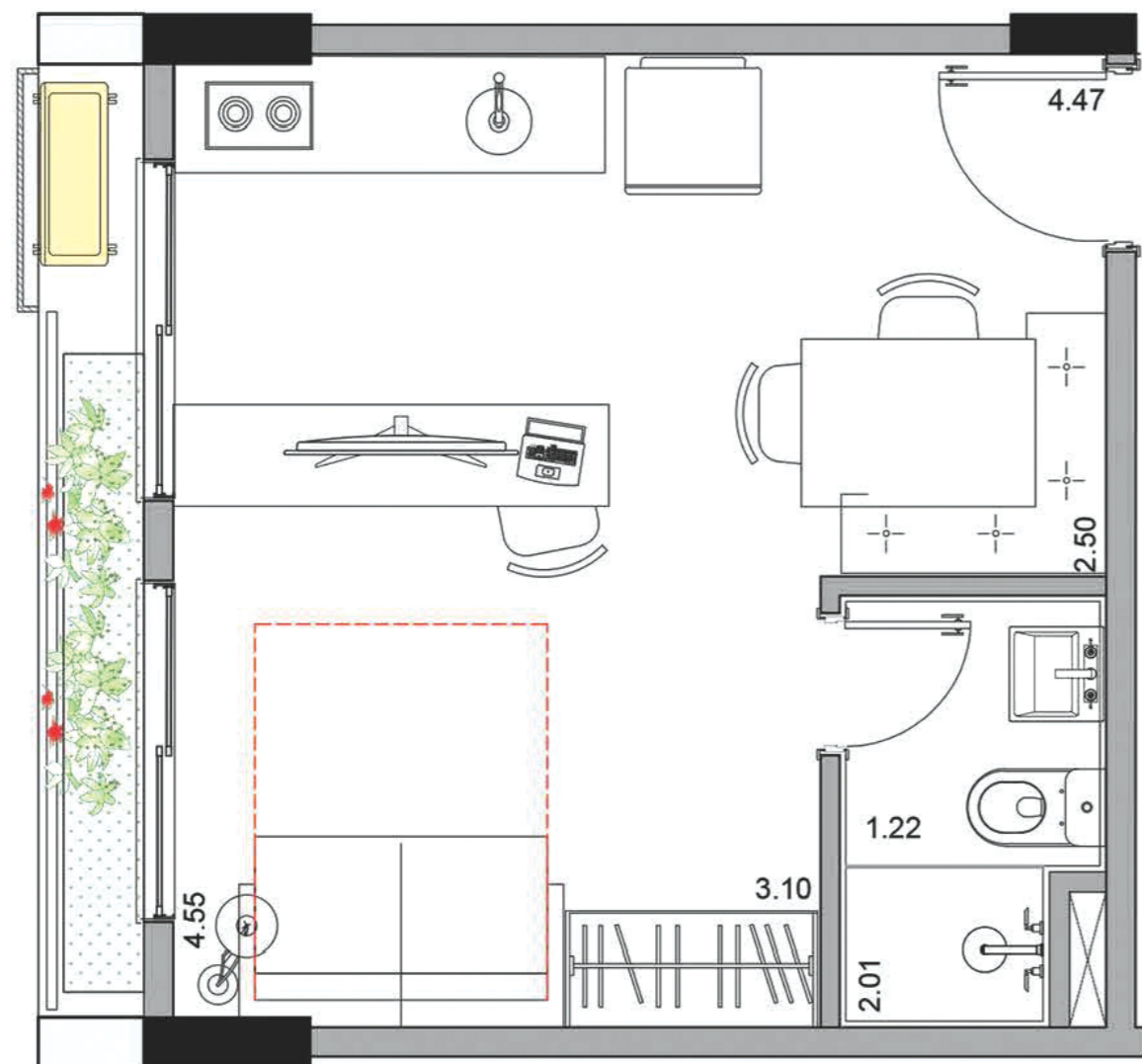

UNIDADE STUDIO PD PADRÃO
FINAL 06 - ANDAR TIPO 4º
40,01 m² (30,08 m² + 9,93 m² descoberto)

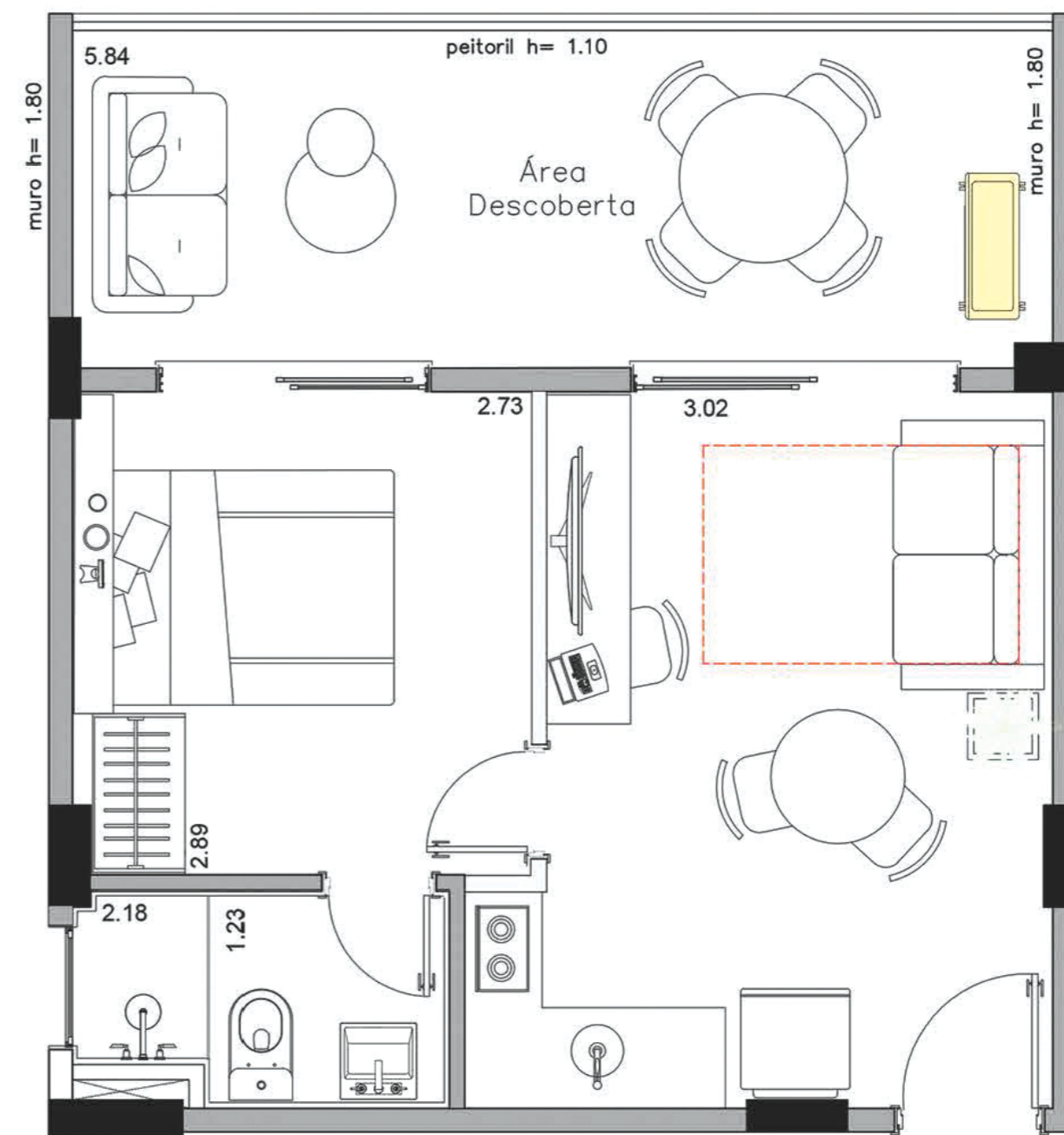

UNIDADE STUDIO PD PADRÃO
FINAL 07 - ANDAR TIPO 4º
60,14 m² (30,08 m² + 30,06 m² descoberto)

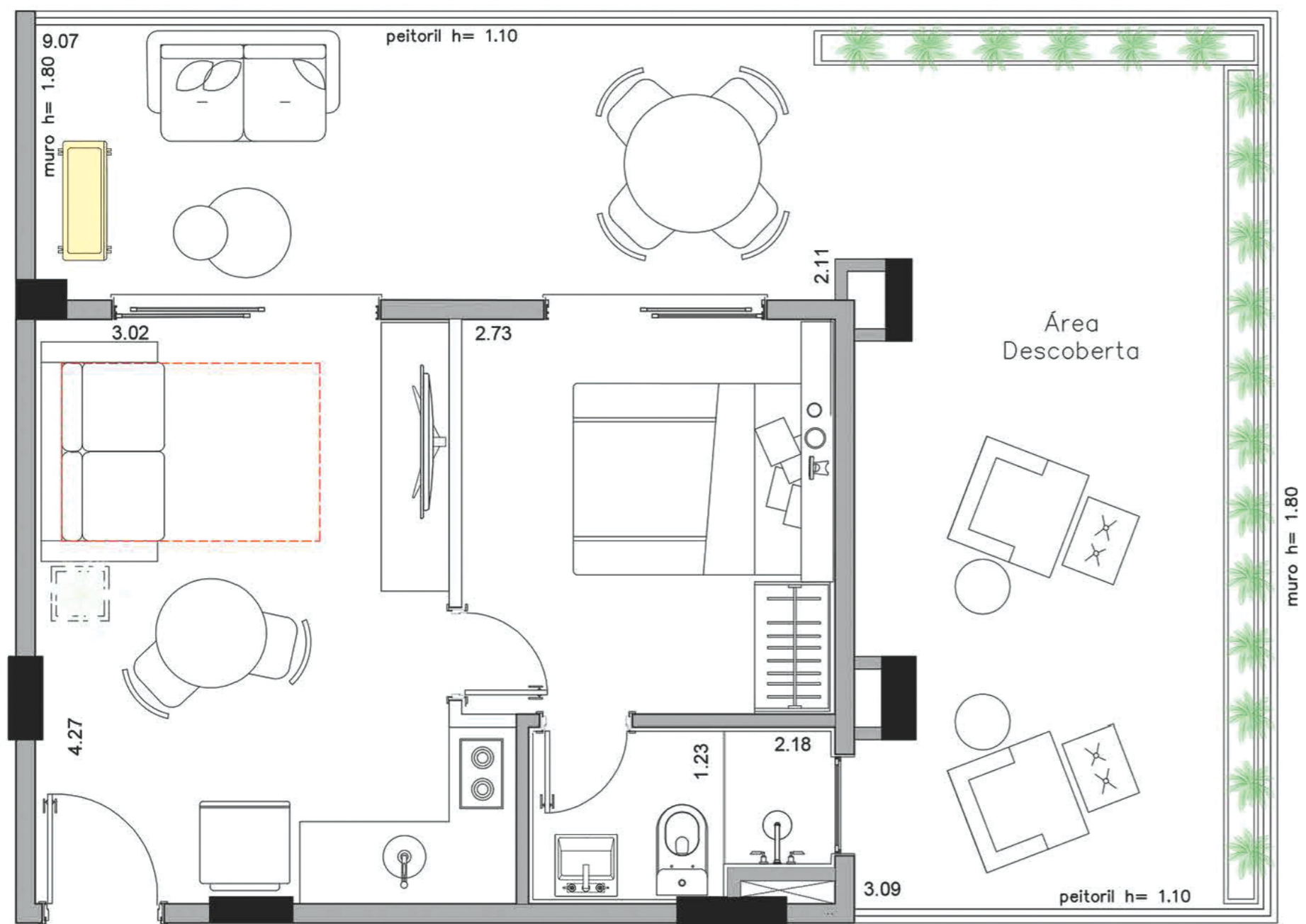

UNIDADE STUDIO PD PADRÃO
FINAL 08 - ANDAR TIPO 4º
29,33 m²

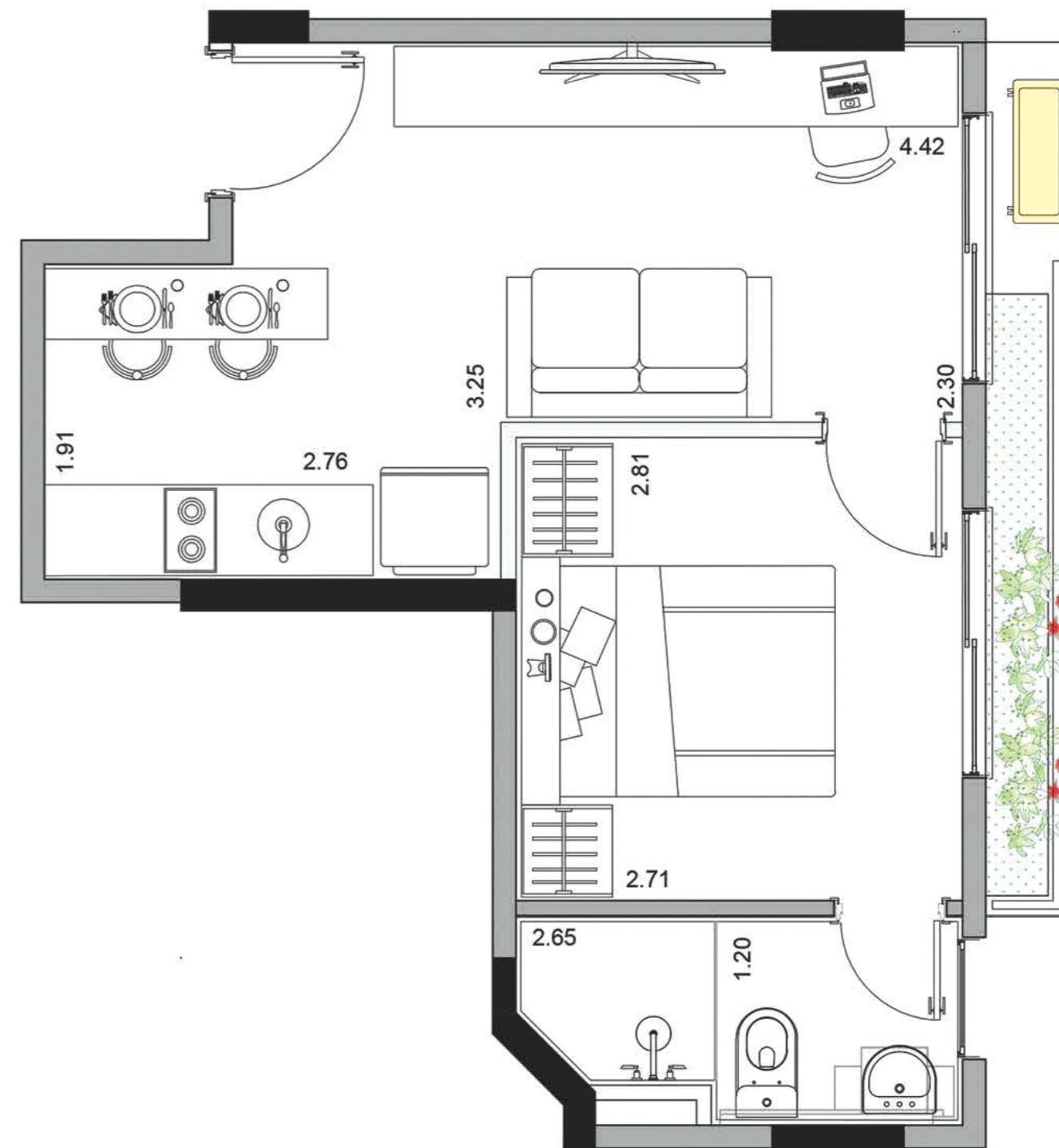

UNIDADE STUDIO PD PADRÃO
FINAL 09 - ANDAR TIPO 4°
36,41 m² (20,11 m² + 16,30 m² descoberto)

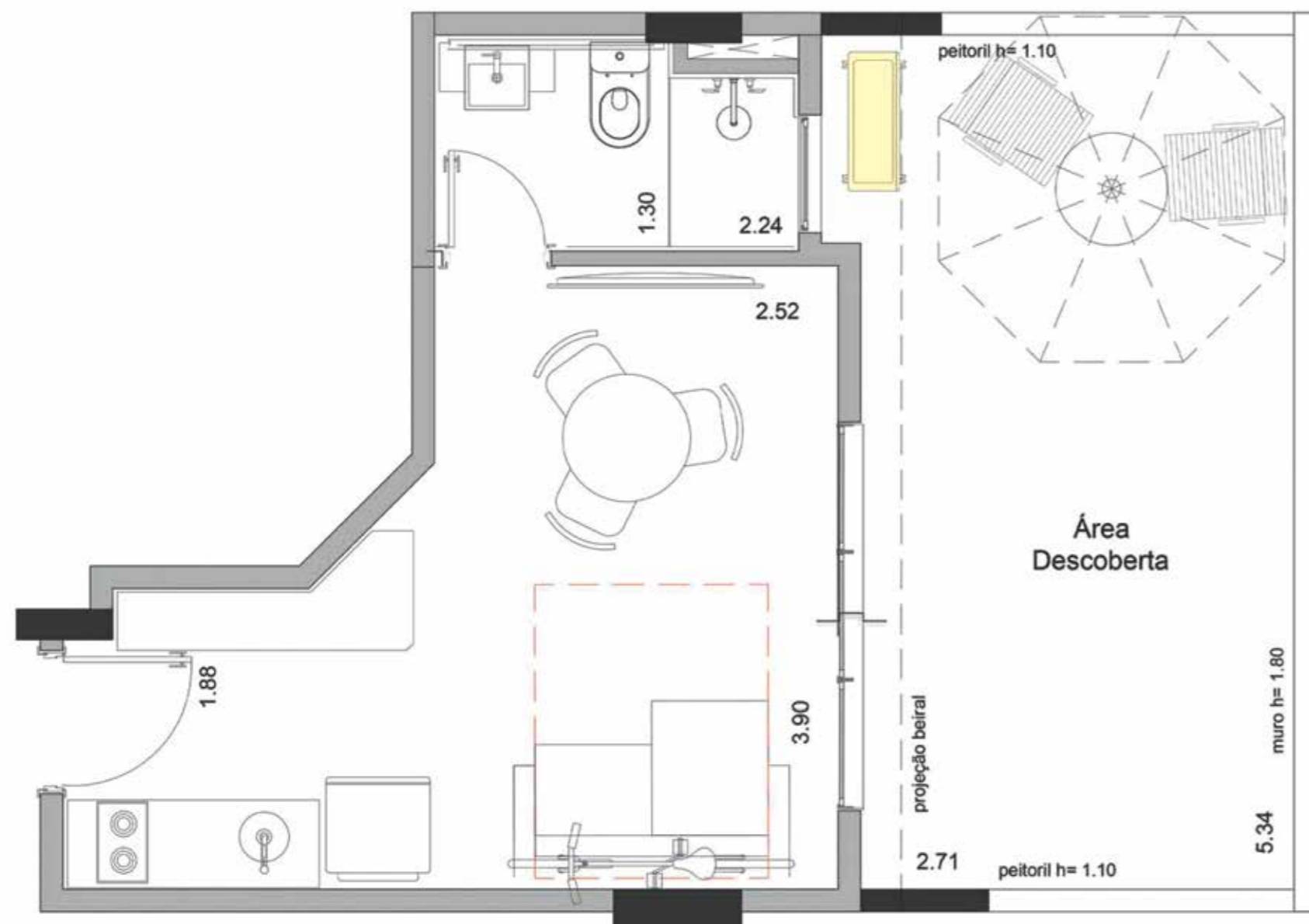

UNIDADE STUDIO PD PADRÃO
FINAL 06 - ANDAR TIPO 4°
19,66 m² (15,69 m² + 3,97 m² descoberto)

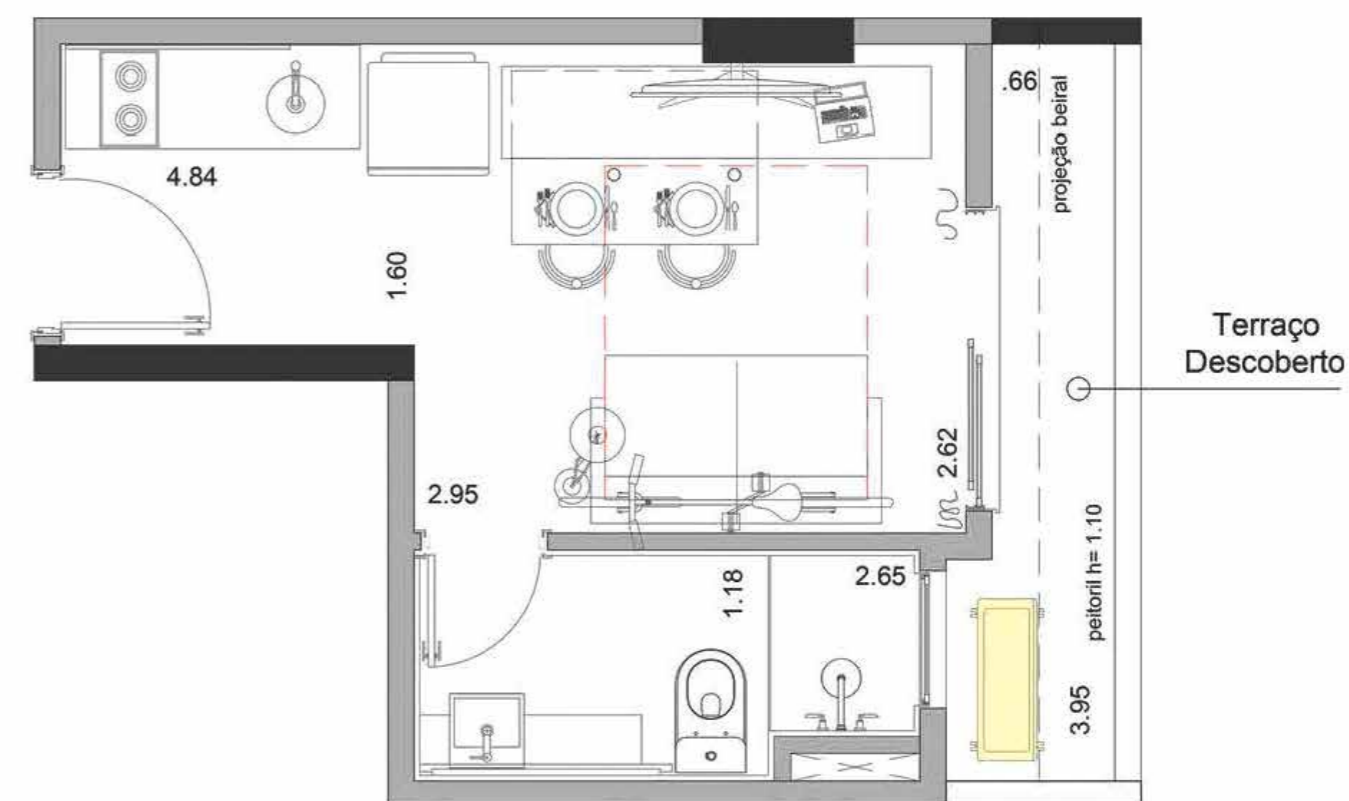

UNIDADE STUDIO PD PADRÃO
FINAL 01 - ANDAR TIPO 5° ao 8°
22,54 m²

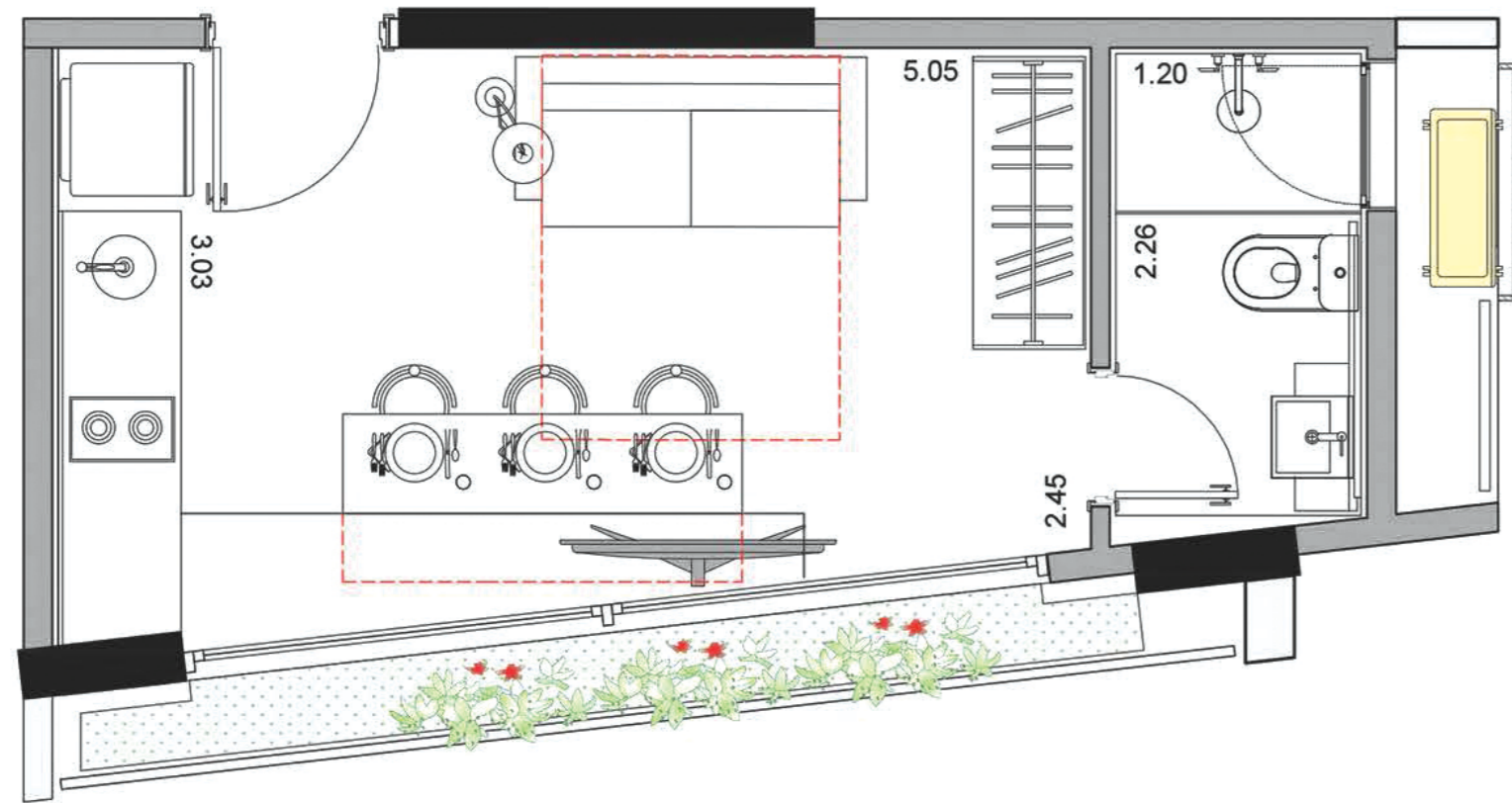

UNIDADE STUDIO PD PADRÃO
FINAL 02 - ANDAR TIPO 5° ao 8°
28,83 m² - Opção de Layout 02

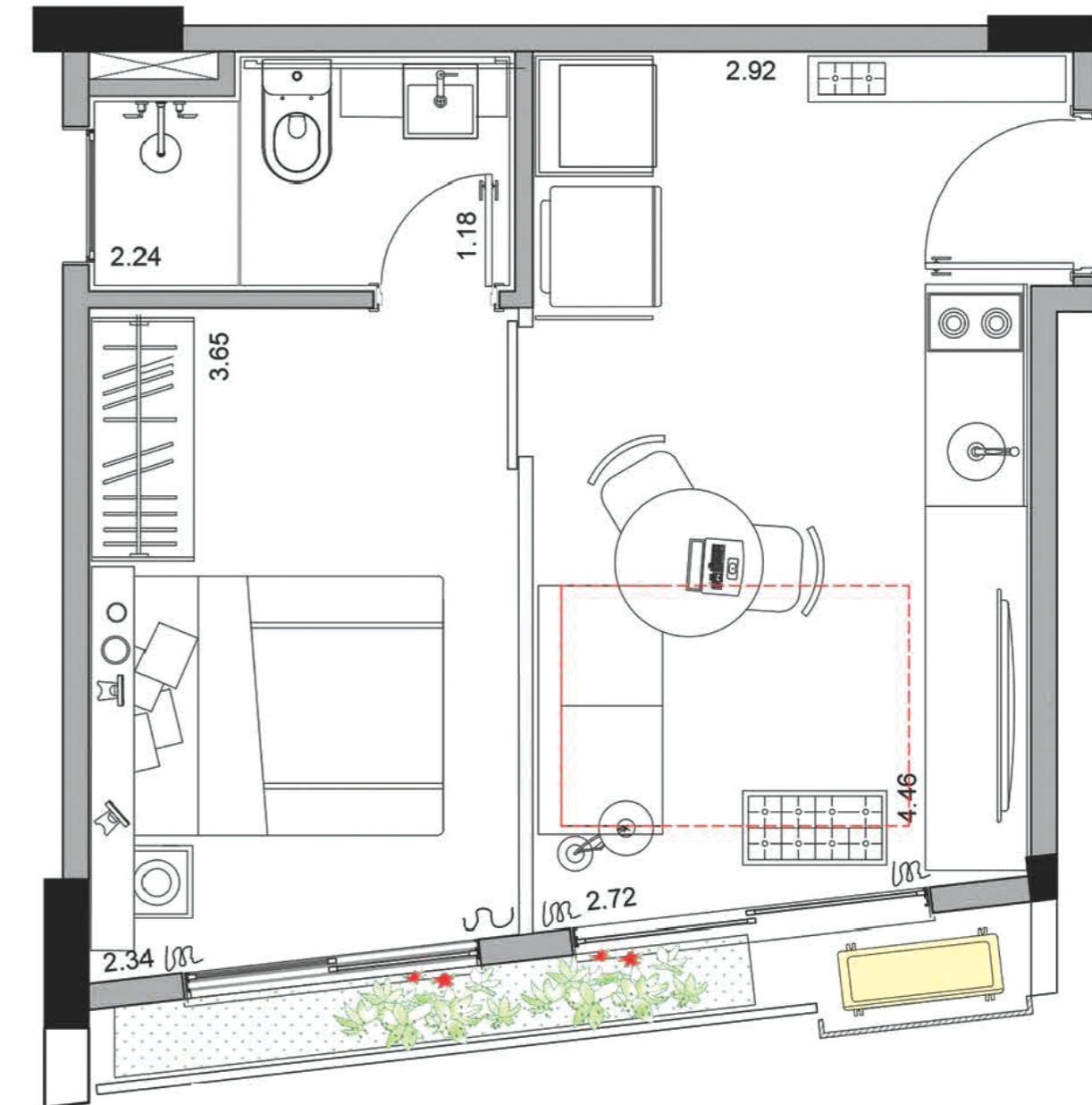

UNIDADE STUDIO PD PADRÃO
FINAL 03 - ANDAR TIPO 5° ao 8°
33,27 m² - Opção de Layout 02

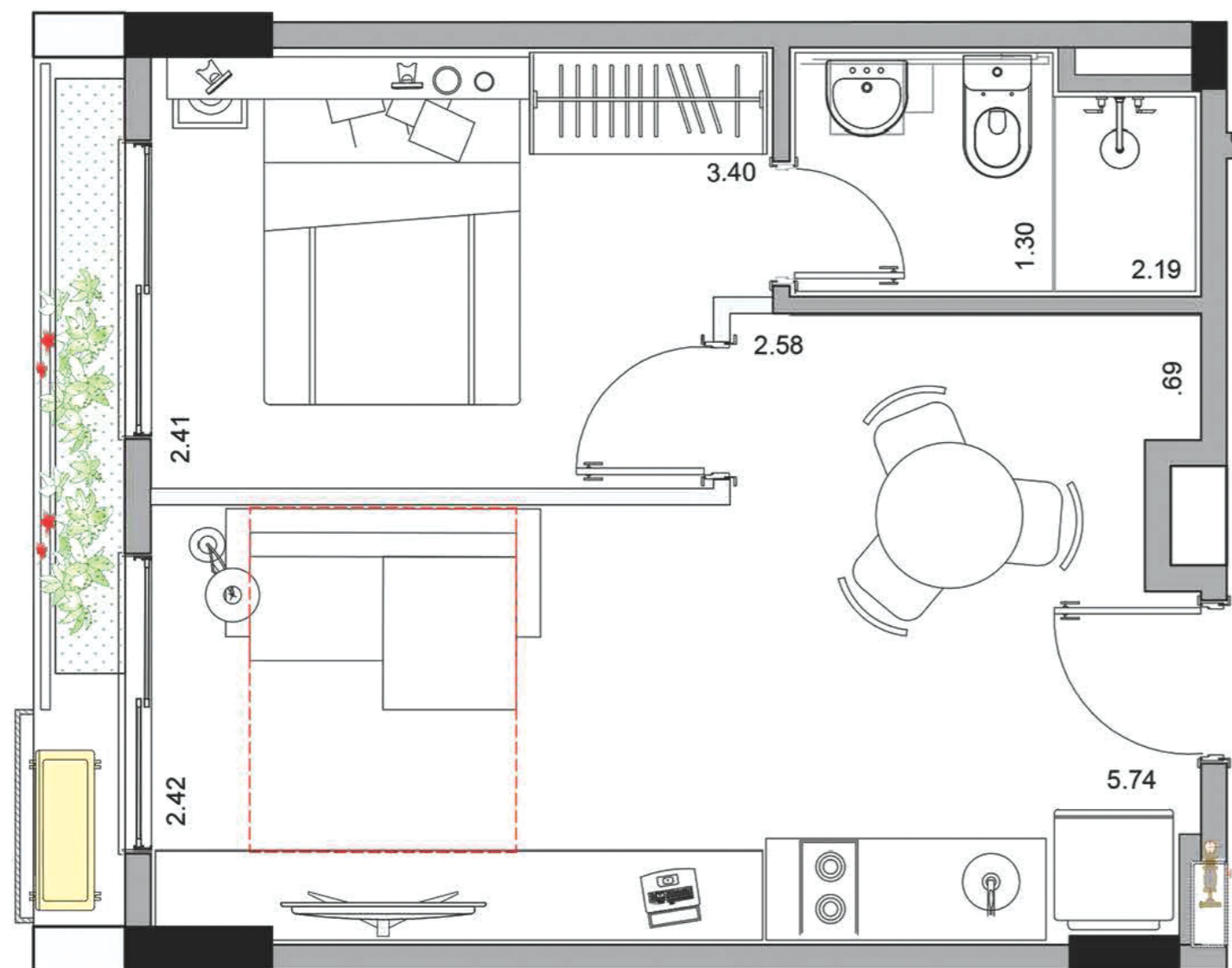

UNIDADE STUDIO PD PADRÃO
FINAL 04 - ANDAR TIPO 5° ao 8°
32,54 m² - Opção de Layout 02

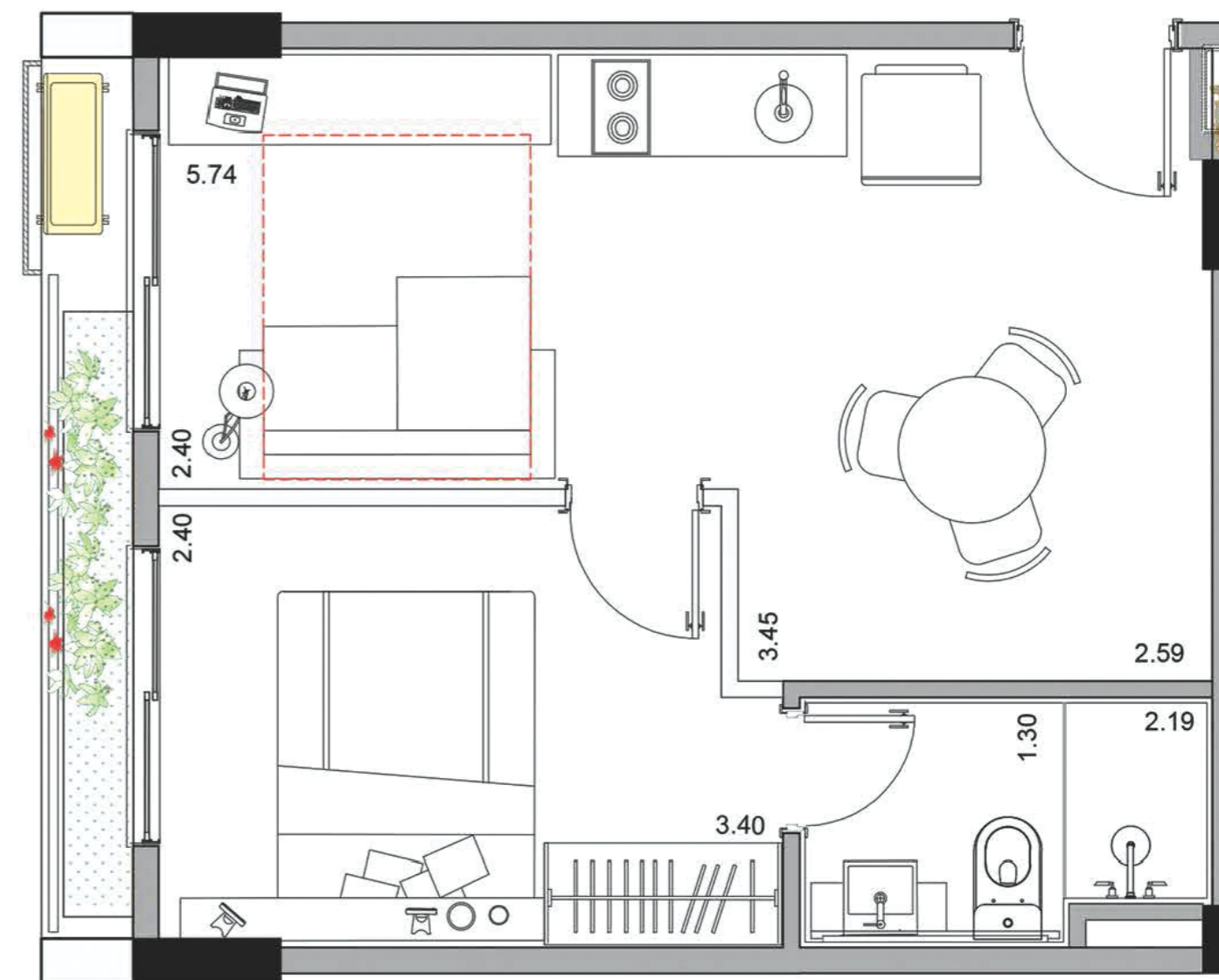

UNIDADE STUDIO PD PADRÃO
FINAL 05 - ANDAR TIPO 5° ao 8°
23,79 m²

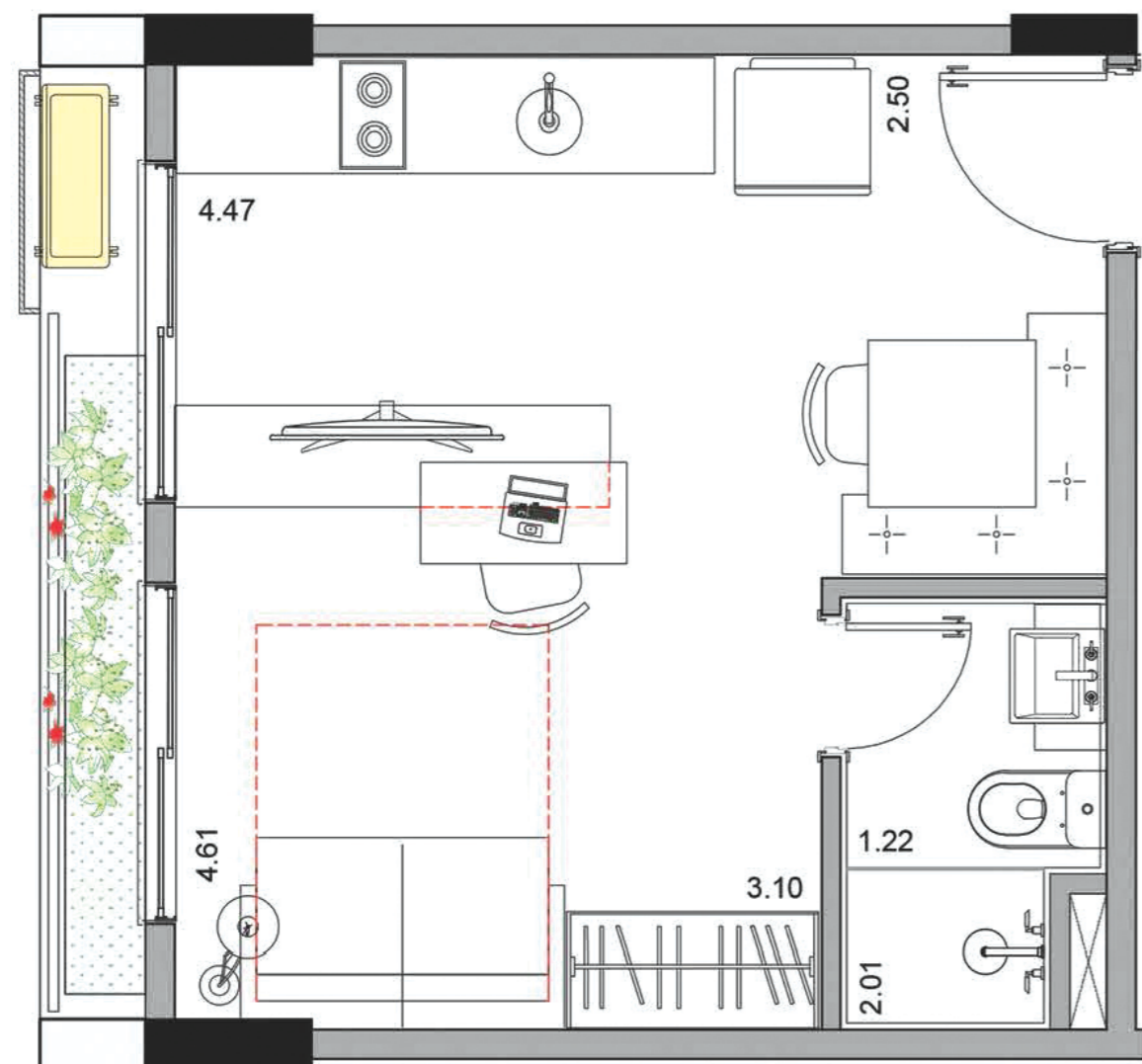

UNIDADE STUDIO PD PADRÃO
FINAL 06 - ANDAR TIPO 5° ao 8°
31,91 m²

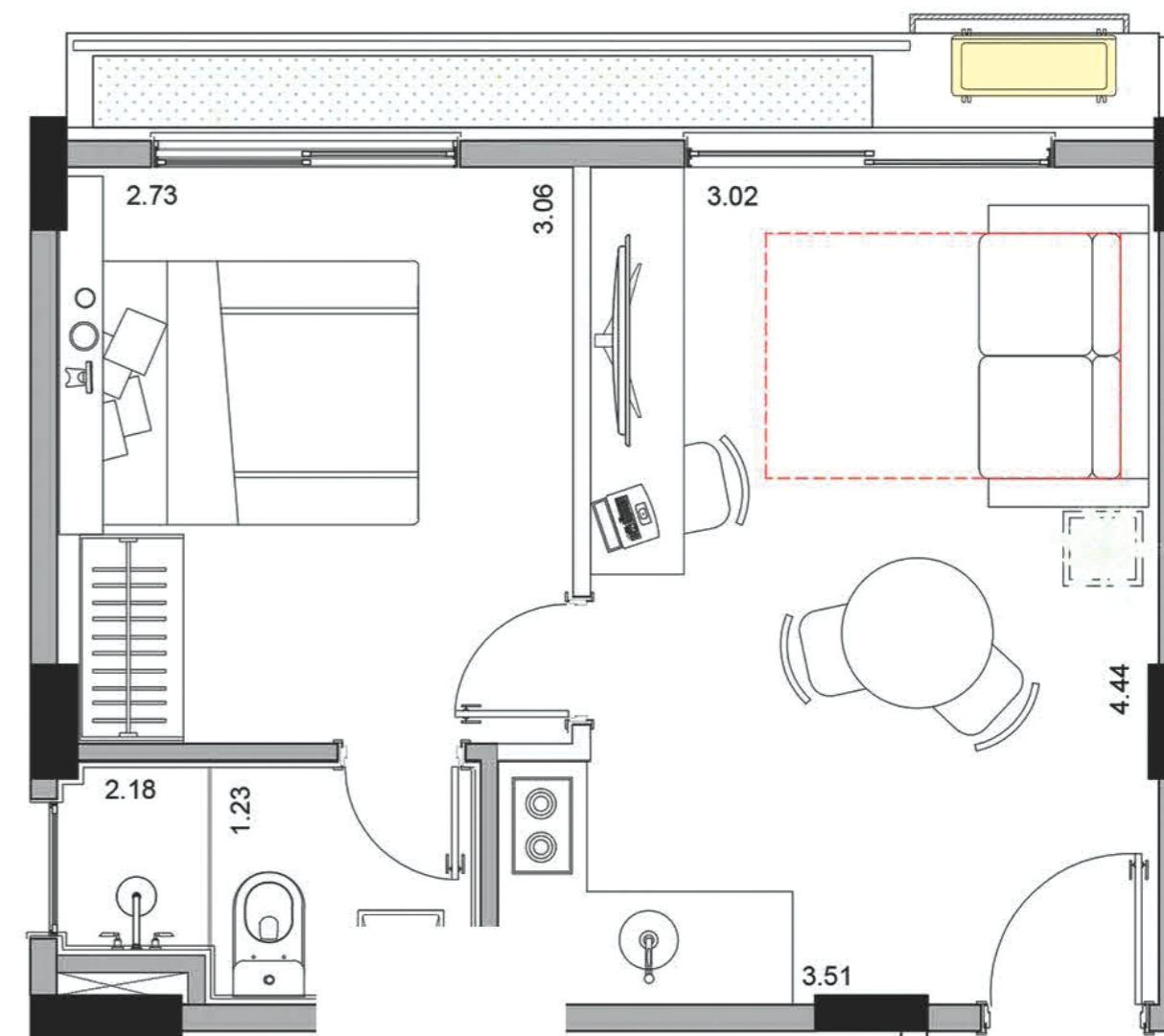

UNIDADE STUDIO PD PADRÃO
FINAL 07 - ANDAR TIPO 5° ao 8°
31,91 m²

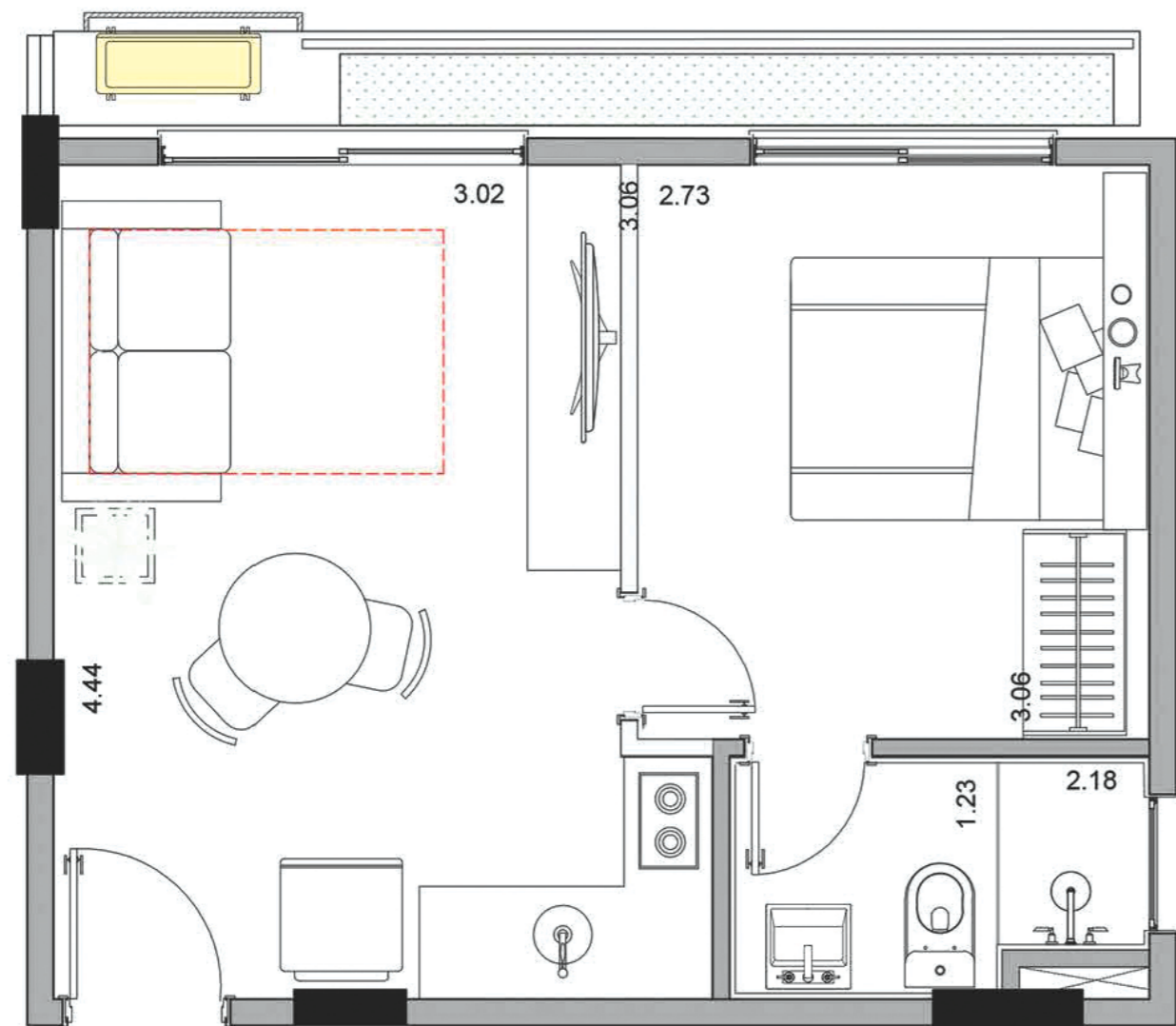

UNIDADE STUDIO PD PADRÃO
FINAL 08 - ANDAR TIPO 5° ao 8°
29,33 m²

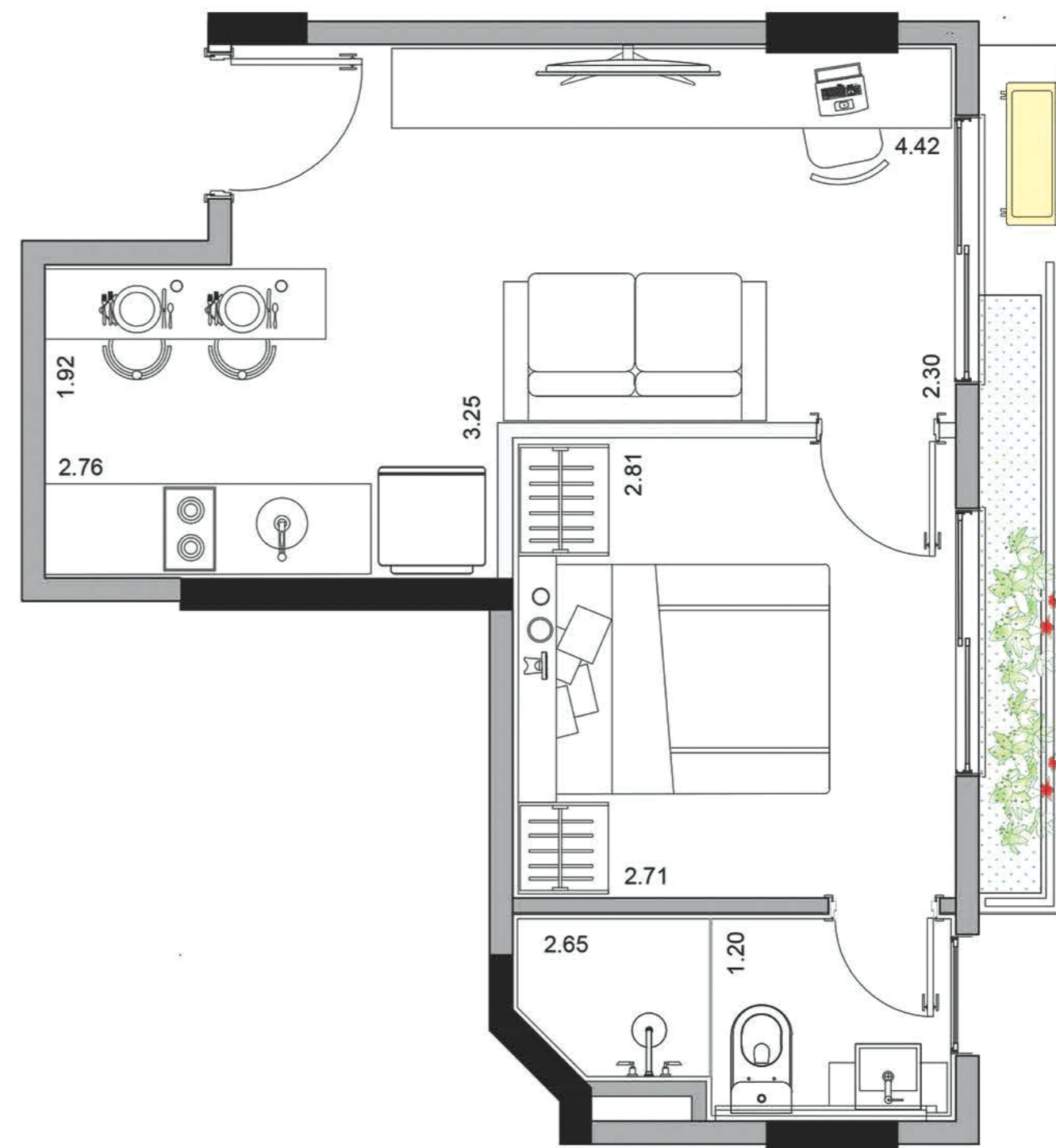

UNIDADE STUDIO PD PADRÃO
FINAL 09 - ANDAR TIPO 5° ao 8°
21,87 m²

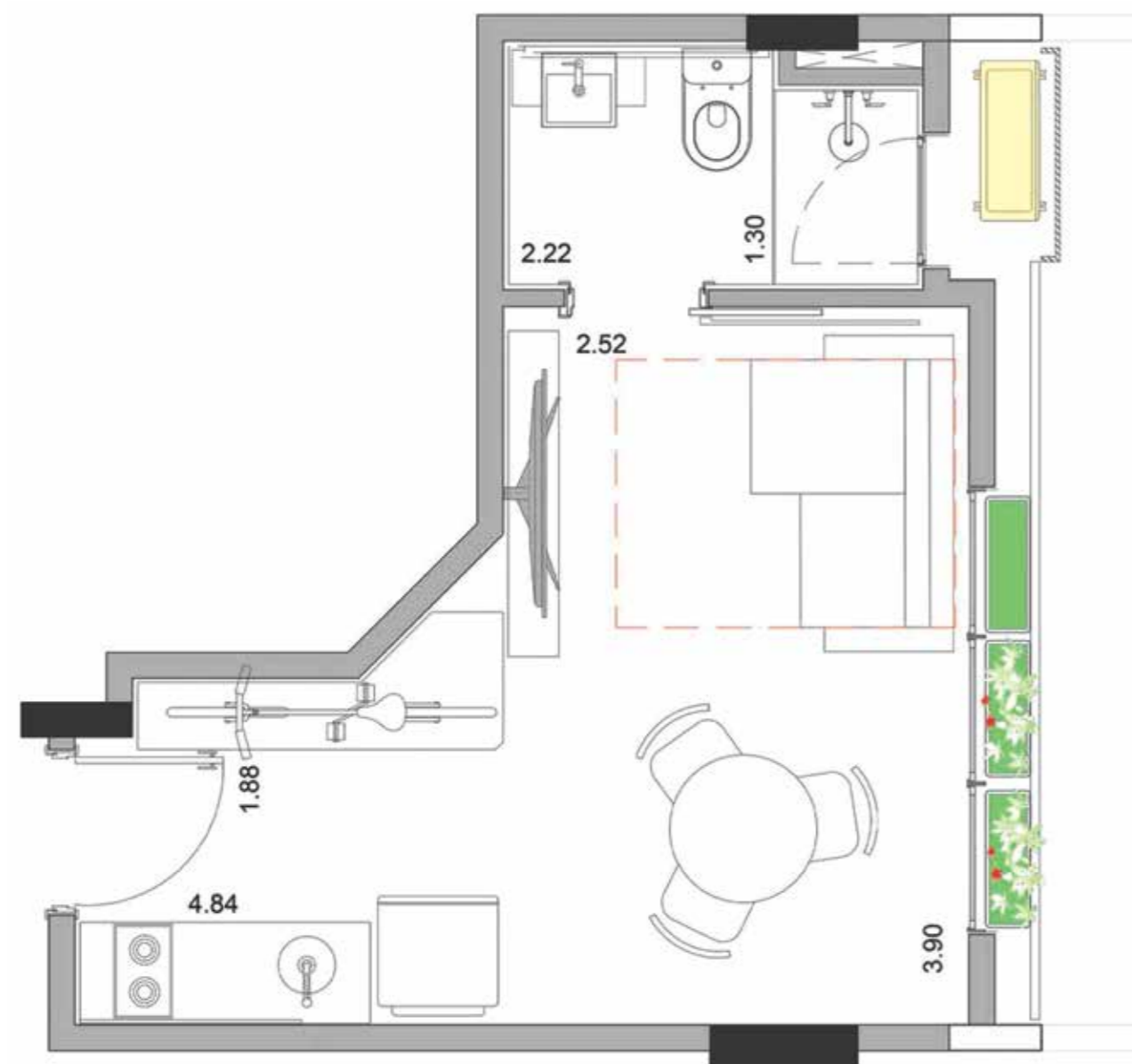

UNIDADE STUDIO PD PADRÃO
FINAL 10 - ANDAR TIPO 5° ao 8°
16,92 m²

